

POWER RELAY

1 POLE—5,10 A (CADMIUM FREE CONTACTS TYPE)

FTR-F2 /H2 SERIES

RoHS compliant

■ FEATURES

- HIGH DENSITY MOUNTING
Saves space by 26% compared to FTR-H1 type.
- HIGH ISOLATION
Insulation Distance: Minimum 6mm between coil and contact
Dielectric Strength: 4KV
Surge Strength: 10KV
- HIGH NOISE RESISTANCE
Uses card separation for high noise resistance between coil and contact
- HEAT RESISTANCE, FLAMMABILITY
Class B (130° C) insulation, flammability 94V-0
- CADMIUM FREE CONTACT FOR ECO-PROGRAM
- SAFETY STANDARDS
UL, CSA, VDE approved, SEMKO (pending)
UL/CSA TV-5 rating approved
- RoHS compliant since date code: 0437L2
Please see page 7 for more information



■ ORDERING INFORMATION

[Example] FTR-F2 A K 012 T -**
 (a) (b) (c) (d) (e) (f)

(a)	Series Name	FTR-F2 : FTR-F2 Series (5A) FTR-H2 : FTR-H2 Series (10A)
(b)	Contact Arrangement	A : 1 Form A (SPST-NO)
(c)	Coil Type	K : Standard (530mW) L : High sensitivity (250mW) FTR-F2/H2 A : Sealed type (530mW) FTR-H2
(d)	Coil Nominal Voltage	005 : 5DC 012 : 12DC 006 : 6DC 024 : 24DC 009 : 9DC 048 : 48DC
(e)	TV-Rating	T : TV-5
(f)	Custom Designation	To be assigned custom specification

FTR-F2/H2 Series

■ SAFETY STANDARD AND FILE NUMBERS

UL508 (File No. E63614)

C22.2 No.1 and No. 14 (File No. LR40304)

VDE 0435, 0860 (File No. 11039-4940-1020)

	Nominal voltage	Contact rating
FTR-F2	5 to 48 VDC	TV-5 125 VAC 1/2 HP 250 VAC 1/6 HP 125 VAC 5 A 250 VAC/ 30 VDC resistive 2 A 250 VAC inductive (PF=0.4) Pilot duty C 300
FTR-H2	5 to 48 VDC	TV-5 120 VAC 1/2 HP 250 VAC 1/6 HP 125 VAC 10 A 30 VDC/250 VAC resistive 3A 250VAC inductive (PF=0.4) Pilot duty C300

FTR-F2/H2 Series

■ SPECIFICATIONS

Item		FTR-F2 Series		FTR-H2 Series	
		Standard	Sensitive	Standard	Sensitive
Contact	Arrangement	1 Form A (SPST-NO)			
	Material	Silver Alloy			
	Resistance (initial)	Maximum 100mΩ (at 1A 6VDC)			
	Rating (resistive)	250VAC / 30VDC, 5A		250VAC / 30VDC, 10A	
	Maximum Carrying Current	5A		10A	
	Maximum Switching Rating	1250VA / 150W		2500VA / 300W	
	Maximum Switching Voltage	400VAC /300DC			
	Maximum Switching Current	5A		10A	
	Minimum Switching Load	100 ma, 5VDC			
	Maximum Inrush Current	78A, 120VAC (at lamp load)			
Coil	Nominal Power (at 20° C)	530mW	250mW	530mW	250mW
	Operate Power (at 20° C)	260mW	160mW	260mW	160mW
	Operating Temperature	-40° C to +70° C (no frost)			
Time Value	Operate Time (at nominal voltage)	Maximum 15ms			
	Release Time (at nominal voltage)	Maximum 5ms			
Insulation	Resistance (at 500VDC)	Minimum 1,000 MΩ			
	Dielectric Strength	Between open contacts	1,000 VAC 1 minute		
		Between coil and contacts	4,000 VAC 1 minute		
	Surge Strength	10,000V (at 1.2 x 50 μs)			
Life	Mechanical	2 x 10 ⁶ operations minimum			
	Electrical	Contact Rating	100 x 10 ³ operations minimum		
		Lamp Load	25 x 10 ³ operations minimum		
Other	Vibration Resistance	Misoperation	10-55 Hz (double amplitude of 1.5mm)		
		Endurance	10-55 Hz (double amplitude of 1.5mm)		
	Shock Resistance	Misoperation	200m/s ² (11±1ms)		
		Endurance	1,000m/s ² (11±1ms)		
	Weight	Approximately 12g			

FTR-F2/H2 Series

COIL DATA CHART

Standard Type (530mW)

MODEL		Nominal Voltage	Coil Resistance (± 10%)	Must Operate Voltage	Must Release Voltage
FTR-F2 Series	FTR-H2 Series				
FTR-F2AK005T	FTR-H2AK005T	5VDC	47Ω	3.5VDC	0.25VDC
FTR-F2AK006T	FTR-H2AK006T	6VDC	68Ω	4.2VDC	0.3VDC
FTR-F2AK009T	FTR-H2AK009T	9VDC	155Ω	6.3VDC	0.45VDC
FTR-F2AK012T	FTR-H2AK012T	12VDC	270Ω	8.4VDC	0.6VDC
FTR-F2AK024T	FTR-H2AK024T	24VDC	1,100Ω	16.8VDC	1.2VDC
FTR-F2AK048T	FTR-H2AK048T	48VDC	4,400Ω	33.6VDC	2.4VDC

Sensitive Type (250mW)

MODEL		Nominal Voltage	Coil Resistance (± 10%)	Must Operate Voltage	Must Release Voltage
FTR-F2 Series	FTR-H2 Series				
FTR-F2AL005T	FTR-H2AL005T	5VDC	100Ω	4.0VDC	0.25VDC
FTR-F2AL006T	FTR-H2AL006T	6VDC	145Ω	4.8VDC	0.30VDC
FTR-F2AL009T	FTR-H2AL009T	9VDC	325Ω	7.2VDC	0.45VDC
FTR-F2AL012T	FTR-H2AL012T	12VDC	575Ω	9.6VDC	0.60VDC
FTR-F2AL024T	FTR-H2AL024T	24VDC	2,310Ω	19.2VDC	1.20VDC

Note: All values in the table are measured at 20°C.

CHARACTERISTIC DATA

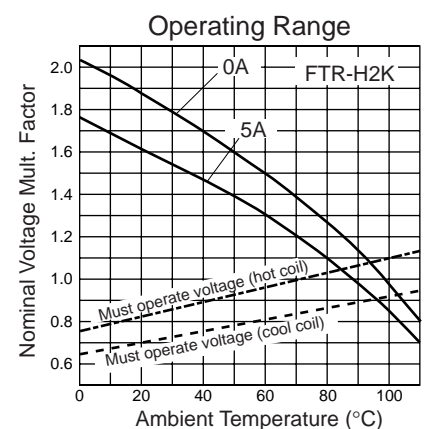
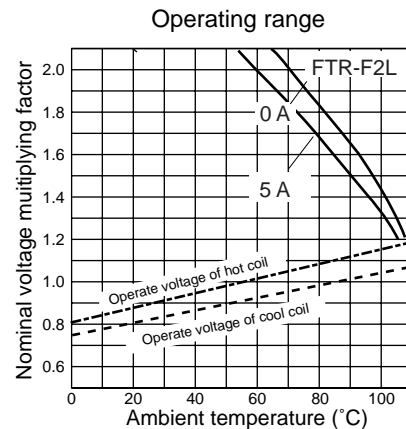
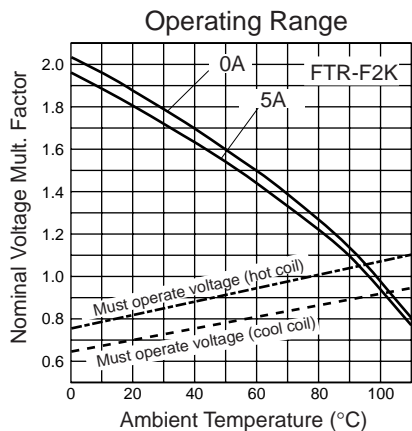
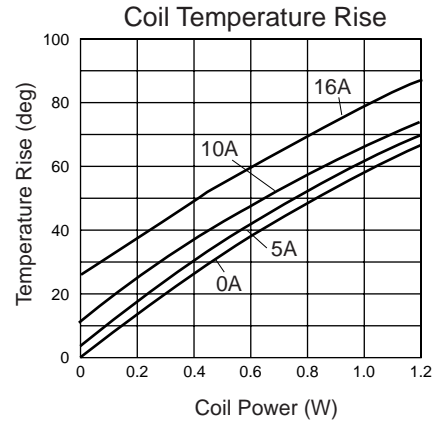
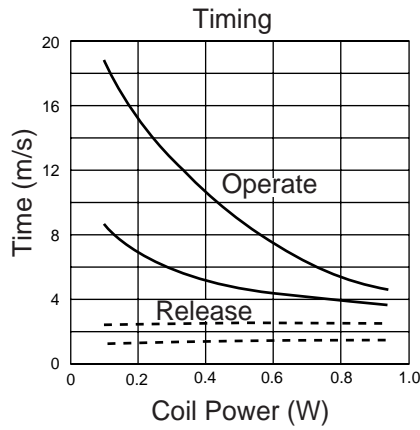
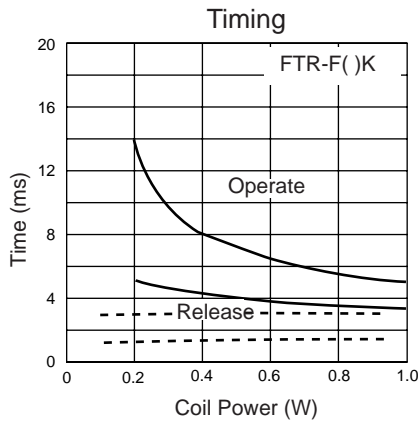

FTR-F2/H2 Series

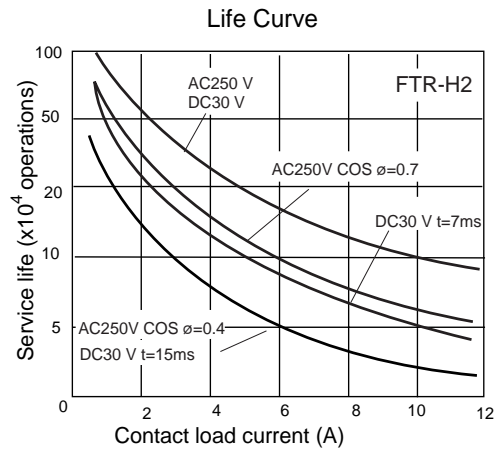
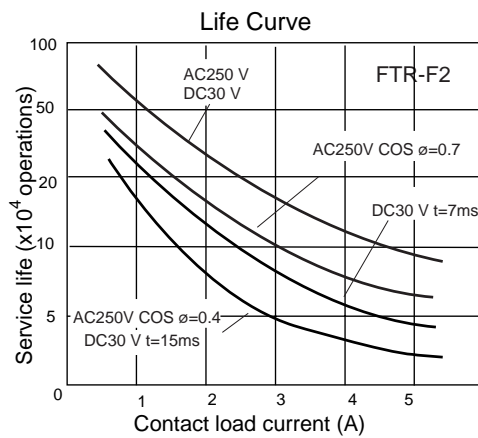
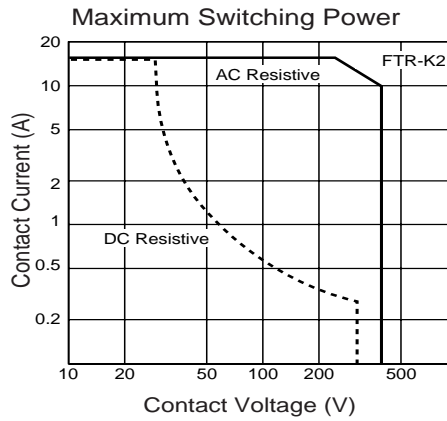
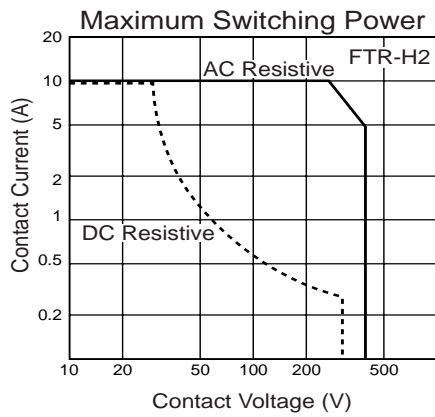
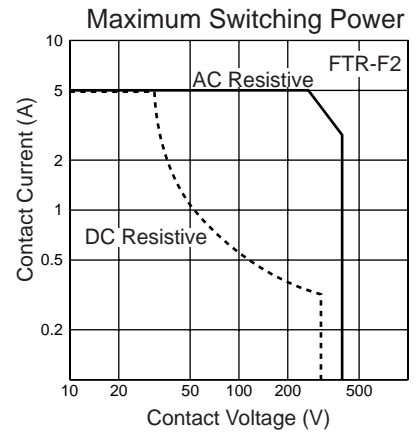
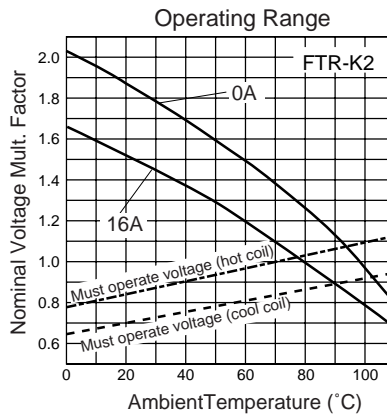
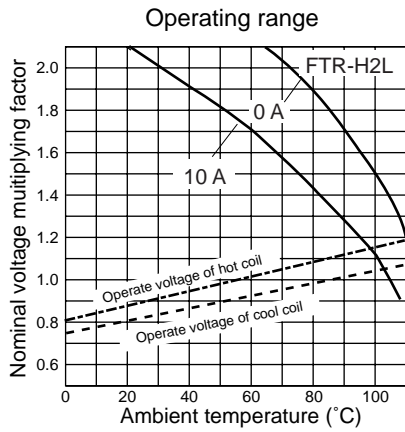

FTR-F2/H2 Series

REFERENCE DATA

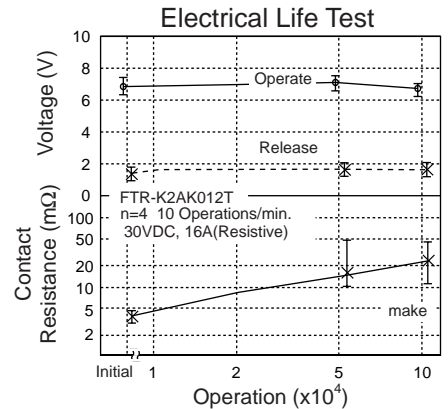
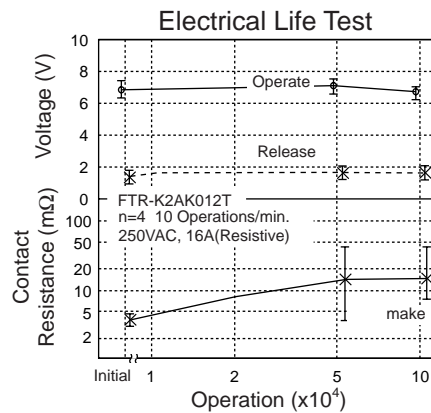
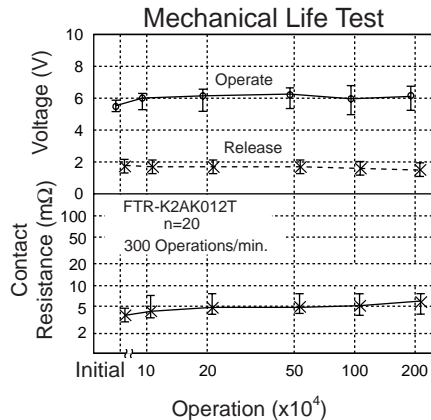
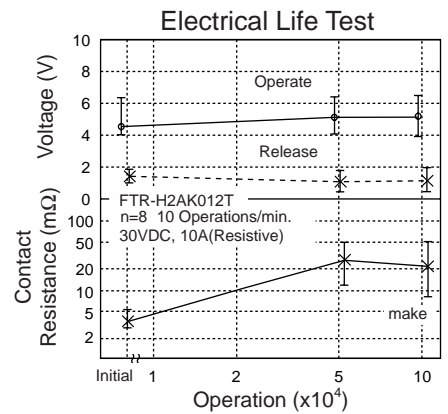
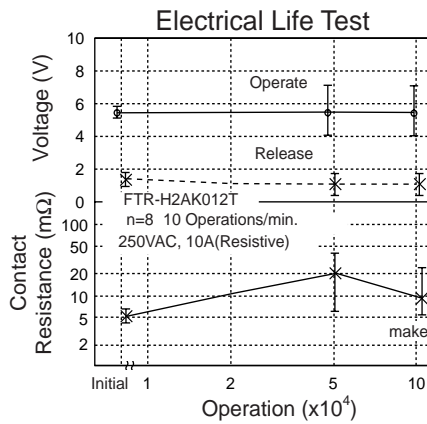
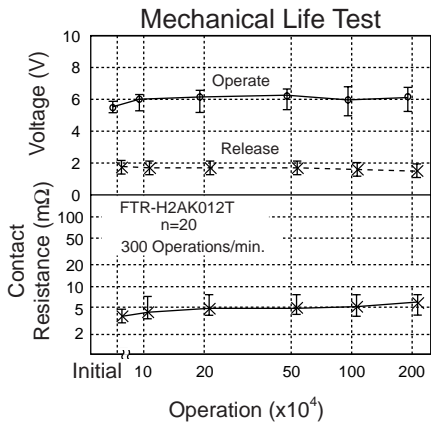
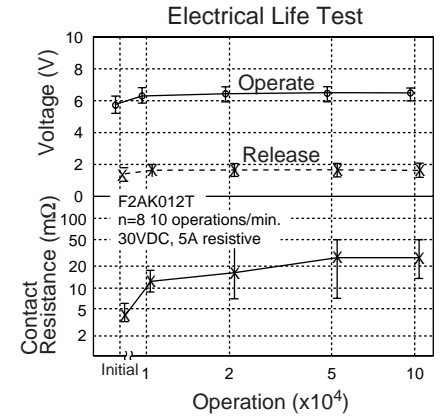
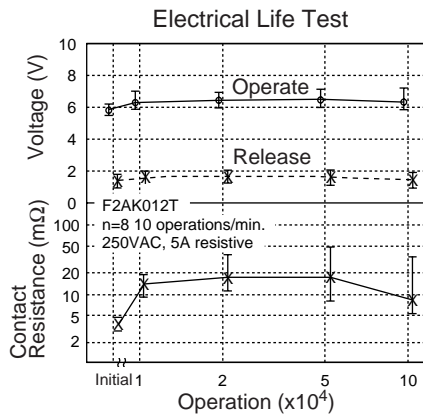
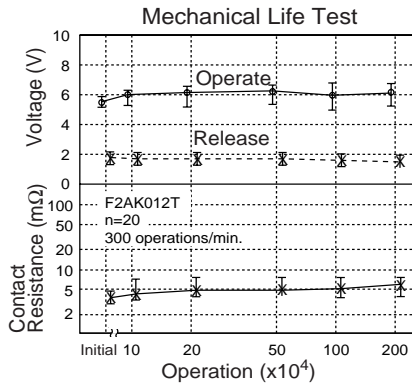
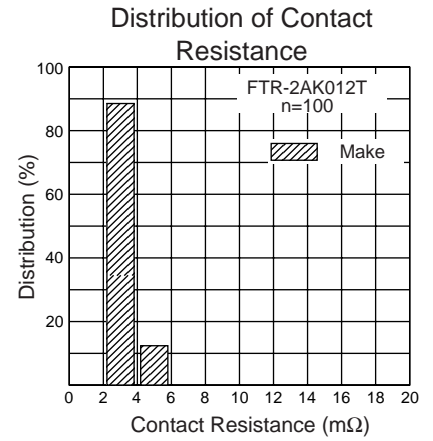
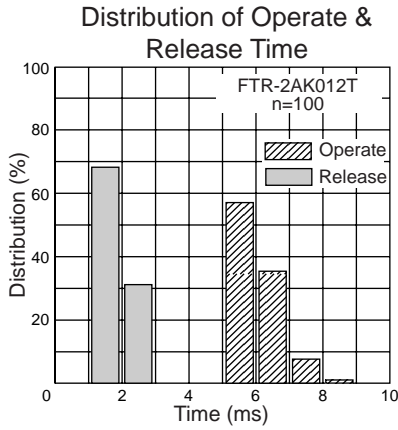
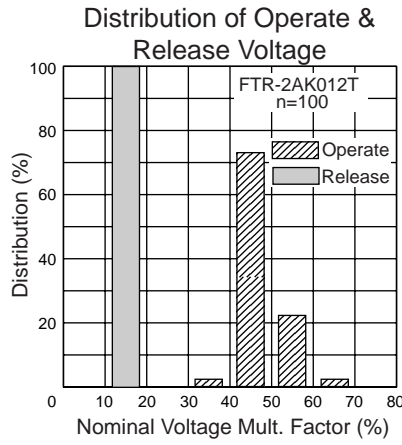

RoHS Compliance and Lead Free Relay Information

1. General Information

- Relays produced after the specific date code that is indicated on each data sheet are lead-free now. Most of our signal and power relays are lead-free. Please refer to Lead-Free Status Info. (<http://www.fcai.fujitsu.com/pdf/LeadFreeLetter.pdf>)
- Lead free solder paste currently used in relays is Sn-3.0Ag-0.5Cu. From February 2005 forward Sn-3.0Cu-Ni will be used for FTRB3 and FTR-B4 series relays.
- Most signal and some power relays also comply with RoHS. Please refer to individual data sheets. Relays that are RoHS compliant do not contain the 6 hazardous materials that are restricted by RoHS directive (lead, mercury, cadmium, chromium IV, PBB, PBDE).
- It has been verified that using lead-free relays in lead assembly process will not cause any problems (compatible).
- "LF" is marked on each outer and inner carton. (No marking on individual relays).
- To avoid leaded relays (for lead-free sample, etc.) please consult with area sales office. We will ship leaded relays as long as the leaded relay inventory exists.

2. Recommended Lead Free Solder Profile

- Recommended solder paste Sn-3.0Ag-0.5Cu and Sn-3.0 Cu-Ni (only FTR-B3 and FTR-B4 from February 2005)

Reflow Solder condition

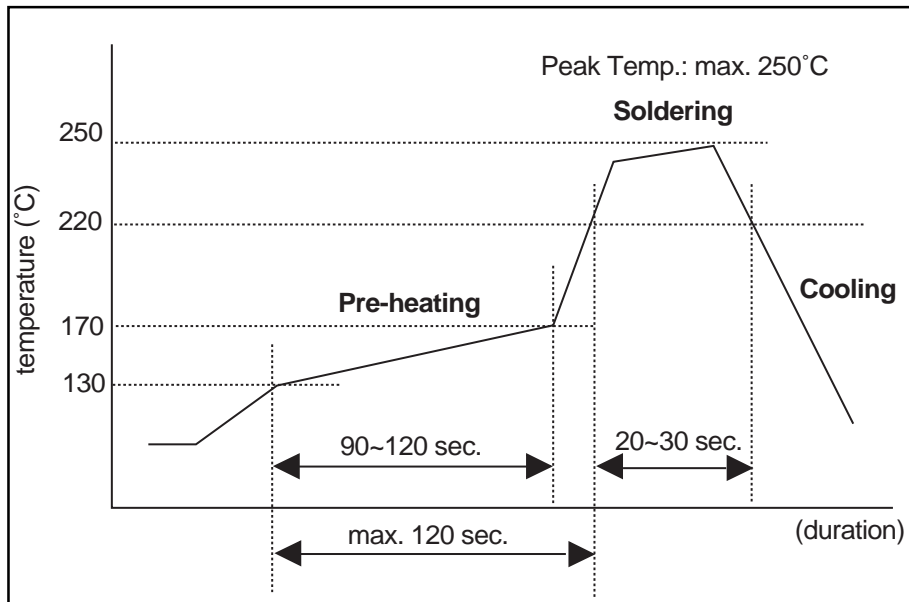

Flow Solder condition:

Pre-heating: maximum 120°C
Soldering: dip within 5 sec. at 260°C solder bath

Solder by Soldering Iron:

Soldering Iron
Temperature: maximum 360°C
Duration: maximum 3 sec.

We highly recommend that you confirm your actual solder conditions

3. Moisture Sensitivity

- Moisture Sensitivity Level standard is not applicable to electromechanical relays.

4. Tin Whisker

- SnAgCu solder is known as low risk of tin whisker. No considerable length whisker was found by our in-house test.

5. Solid State Relays

- Each lead terminal will be changed from solder plating to Sn plating and Nickel plating. A layer of Nickel plating is between the terminal and the Sn plating to avoid whisker.

FTR-F2/H2 Series

■ DIMENSIONS

● Dimensions

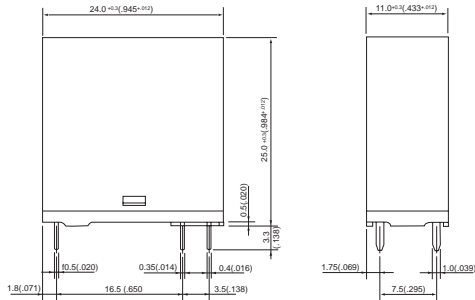

● Schematics (BOTTOM VIEW)

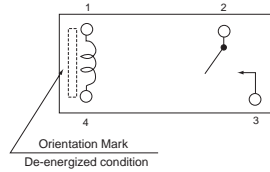

● PC board mounting hole layout (BOTTOM VIEW)

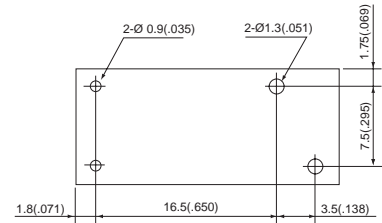

Unit: mm (in.)

Fujitsu Components International Headquarter Offices

Japan

Fujitsu Component Limited
Gotanda-Chuo Building
3-5, Higashigotanda 2-chome, Shinagawa-ku
Tokyo 141, Japan
Tel: (81-3) 5449-7010
Fax: (81-3) 5449-2626
Email: promothq@ft.ed.fujitsu.com
Web: www.fcl.fujitsu.com

North and South America

Fujitsu Components America, Inc.
250 E. Caribbean Drive
Sunnyvale, CA 94089 U.S.A.
Tel: (1-408) 745-4900
Fax: (1-408) 745-4970
Email: marcom@fcai.fujitsu.com
Web: www.fcai.fujitsu.com

Europe

Fujitsu Components Europe B.V.
Diamantlaan 25
2132 WV Hoofddorp
Netherlands
Tel: (31-23) 5560910
Fax: (31-23) 5560950
Email: info@fceu.fujitsu.com
Web: www.fceu.fujitsu.com

Asia Pacific

Fujitsu Components Asia Ltd.
102E Pasir Panjang Road
#04-01 Citilink Warehouse Complex
Singapore 118529
Tel: (65) 6375-8560
Fax: (65) 6273-3021
Email: fcalfcal.fujitsu.com
www.fcal.fujitsu.com

© 2005 Fujitsu Components America, Inc. All company and product names are trademarks or registered trademarks of their respective owners. Rev. 07/19/2005.