

### Agency Approvals

AGENCY	AGENCY FILE NUMBER
	E230531

### Maximum Ratings and Thermal Characteristics ( $T_A=25^\circ\text{C}$ unless otherwise noted)

Parameter	Symbol	Value	Unit
Peak Pulse Power Dissipation by 10x1000 $\mu\text{s}$ test waveform (Fig.1) (Note 1)	$P_{PPM}$	400	W
Steady State Power Dissipation on infinite heat sink at $T_L=75^\circ\text{C}$ (Fig. 5)	$P_D$	1.5	W
Peak Forward Surge Current, 8.3ms Single Half Sine Wave Unidirectional only (Note 2)	$I_{FSM}$	40	A
Maximum Instantaneous Forward Voltage at 25A for Unidirectional only (Note 3)	$V_F$	3.5/5.0	V
Operating Junction and Storage Temperature Range	$T_J, T_{STG}$	-55 to 175	$^\circ\text{C}$
Typical Thermal Resistance Junction to Lead	$R_{\theta JL}$	60	$^\circ\text{C/W}$
Typical Thermal Resistance Junction to Ambient	$R_{\theta JA}$	100	$^\circ\text{C/W}$

#### Notes:

1. Non-repetitive current pulse, per Fig. 3 and derated above  $T_A = 25^\circ\text{C}$  per Fig. 2.
2. Measured on 8.3ms single half sine wave or equivalent square wave, duty cycle=4 per minute maximum.
3.  $V_F < 3.5\text{V}$  for devices of  $V_{BR} \leq 200\text{V}$  and  $V_F < 5.0\text{V}$  for devices of  $V_{BR} \geq 201\text{V}$ .

### Description

The P4KE Series is designed specifically to protect sensitive electronic equipment from voltage transients induced by lightning and other transient voltage events.

### Features

- RoHS compliant
- Typical maximum temperature coefficient  $\Delta V_{BR} = 0.1\% \times V_{BR} @ 25^\circ\text{C}$
- Glass passivated chip junction in DO-41 Package
- 400W peak pulse capability at 10x1000 $\mu\text{s}$  waveform, repetition rate (duty cycles):0.01 %
- Fast response time: typically less than 1.0ps from 0 Volts to BV min
- Excellent clamping capability
- Low incremental surge resistance
- Typical  $I_R$  less than 1 $\mu\text{A}$  above 13V
- High temperature soldering guaranteed: 260 $^\circ\text{C}$ /40 seconds / 0.375"(9.5mm) lead length, 5 lbs., (2.3kg) tension
- Plastic package has Underwriters Laboratory Flammability classification 94V-O
- Matte Tin Lead-free plated

### Applications

TVS devices are ideal for the protection of I/O interfaces,  $V_{CC}$  bus and other vulnerable circuits used in telecom, computer, industrial and consumer electronic applications.

### Electrical Characteristics

Part Number (Uni)	Part Number (Bi)	Reverse Stand off Voltage $V_R$ (Volts)	Breakdown Voltage $V_{BR} @ I_T$ (V)		Test Current $I_T$ (mA)	Maximum Clamping Voltage $V_C @ I_{PP}$ (V)	Maximum Peak Pulse Current $I_{PP}$ (A)	Maximum Reverse Leakage $I_R @ V_R$ ( $\mu$ A)	Agency Approval 
			MIN	MAX					
P4KE6.8A	P4KE6.8CA	5.80	6.45	7.14	10	10.5	39.00	1000	X
P4KE7.5A	P4KE7.5CA	6.40	7.13	7.88	10	11.3	36.30	500	X
P4KE8.2A	P4KE8.2CA	7.02	7.79	8.61	10	12.1	33.90	200	X
P4KE9.1A	P4KE9.1CA	7.78	8.65	9.55	1	13.4	30.60	50	X
P4KE10A	P4KE10CA	8.55	9.50	10.50	1	14.5	28.30	10	X
P4KE11A	P4KE11CA	9.40	10.50	11.60	1	15.6	26.30	5	X
P4KE12A	P4KE12CA	10.20	11.40	12.60	1	16.7	24.60	5	X
P4KE13A	P4KE13CA	11.10	12.40	13.70	1	18.2	22.50	1	X
P4KE15A	P4KE15CA	12.80	14.30	15.80	1	21.2	19.30	1	X
P4KE16A	P4KE16CA	13.60	15.20	16.80	1	22.5	18.20	1	X
P4KE18A	P4KE18CA	15.30	17.10	18.90	1	25.5	16.10	1	X
P4KE20A	P4KE20CA	17.10	19.00	21.00	1	27.7	14.80	1	X
P4KE22A	P4KE22CA	18.80	20.90	23.10	1	30.6	13.40	1	X
P4KE24A	P4KE24CA	20.50	22.80	25.20	1	33.2	12.30	1	X
P4KE27A	P4KE27CA	23.10	25.70	28.40	1	37.5	10.90	1	X
P4KE30A	P4KE30CA	25.60	28.50	31.50	1	41.4	9.90	1	X
P4KE33A	P4KE33CA	28.20	31.40	34.70	1	45.7	9.00	1	X
P4KE36A	P4KE36CA	30.80	34.20	37.80	1	49.9	8.20	1	X
P4KE39A	P4KE39CA	33.30	37.10	41.00	1	53.9	7.60	1	X
P4KE43A	P4KE43CA	36.80	40.90	45.20	1	59.3	6.90	1	X
P4KE47A	P4KE47CA	40.20	44.70	49.40	1	64.8	6.30	1	X
P4KE51A	P4KE51CA	43.60	48.50	53.60	1	70.1	5.80	1	X
P4KE56A	P4KE56CA	47.80	53.20	58.80	1	77.0	5.30	1	X
P4KE62A	P4KE62CA	53.00	58.90	65.10	1	85.0	4.80	1	X
P4KE68A	P4KE68CA	58.10	64.60	71.40	1	92.0	4.50	1	X
P4KE75A	P4KE75CA	64.10	71.30	78.80	1	103.0	4.00	1	X
P4KE82A	P4KE82CA	70.10	77.90	86.10	1	113.0	3.60	1	X
P4KE91A	P4KE91CA	77.80	86.50	95.50	1	125.0	3.30	1	X
P4KE100A	P4KE100CA	85.50	95.00	105.00	1	137.0	3.00	1	X
P4KE110A	P4KE110CA	94.00	105.00	116.00	1	152.0	2.70	1	X
P4KE120A	P4KE120CA	102.00	114.00	126.00	1	165.0	2.50	1	X
P4KE130A	P4KE130CA	111.00	124.00	137.00	1	179.0	2.30	1	X
P4KE150A	P4KE150CA	128.00	143.00	158.00	1	207.0	2.00	1	X
P4KE160A	P4KE160CA	136.00	152.00	168.00	1	219.0	1.90	1	X
P4KE170A	P4KE170CA	145.00	162.00	179.00	1	234.0	1.80	1	X
P4KE180A	P4KE180CA	154.00	171.00	189.00	1	246.0	1.70	1	X
P4KE200A	P4KE200CA	171.00	190.00	210.00	1	274.0	1.50	1	X
P4KE220A	P4KE220CA	185.00	209.00	231.00	1	328.0	1.30	1	X
P4KE250A	P4KE250CA	214.00	237.00	263.00	1	344.0	1.20	1	X
P4KE300A	P4KE300CA	256.00	285.00	315.00	1	414.0	1.00	1	X
P4KE350A	P4KE350CA	300.00	332.00	368.00	1	482.0	0.85	1	X
P4KE400A	P4KE400CA	342.00	380.00	420.00	1	548.0	0.75	1	X
P4KE440A	P4KE440CA	376.00	418.00	462.00	1	602.0	0.68	1	X
P4KE480A	P4KE480CA	408.00	456.00	504.00	1	658.0	0.61	1	
P4KE510A	P4KE510CA	434.00	485.00	535.00	1	698.0	0.57	1	
P4KE530A	P4KE530CA	477.00	503.50	556.50	1	725.0	0.55	1	
P4KE540A	P4KE540CA	486.00	513.00	567.00	1	740.0	0.54	1	
P4KE550A	P4KE550CA	495.00	522.50	577.50	1	760.0	0.52	1	

For bidirectional type having  $V_R$  of 10 volts and less, the  $I_R$  limit is double.

For parts without A, the  $V_{BR}$  is  $\pm 10\%$  and  $V_C$  is 5% higher than with A parts

### Ratings and Characteristic Curves ( $T_A=25^\circ\text{C}$ unless otherwise noted)

#### Figure 1 - Peak Pulse Power Rating

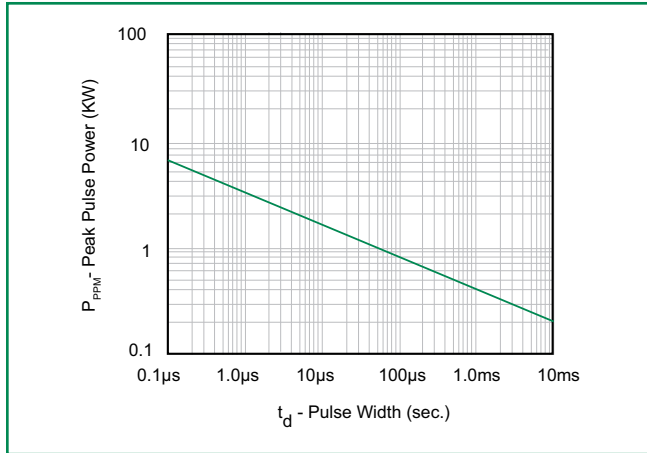

#### Figure 2 - Pulse Derating Curve

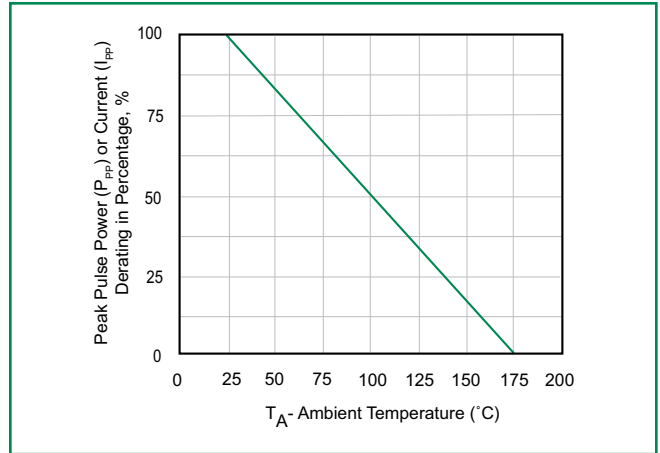

#### Figure 3 - Pulse Waveform

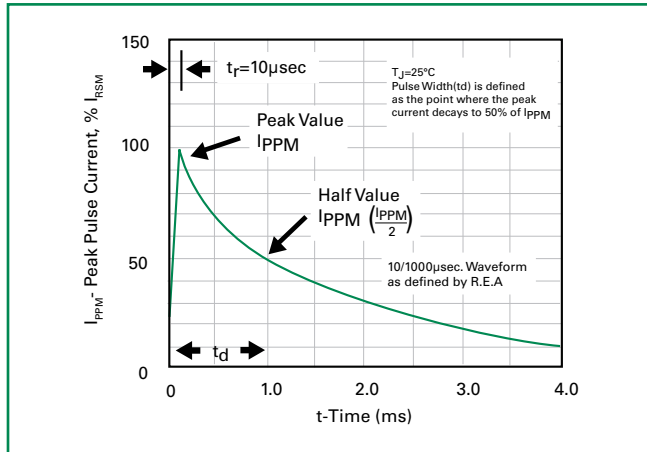

#### Figure 4 - Typical Junction Capacitance Uni-Directional

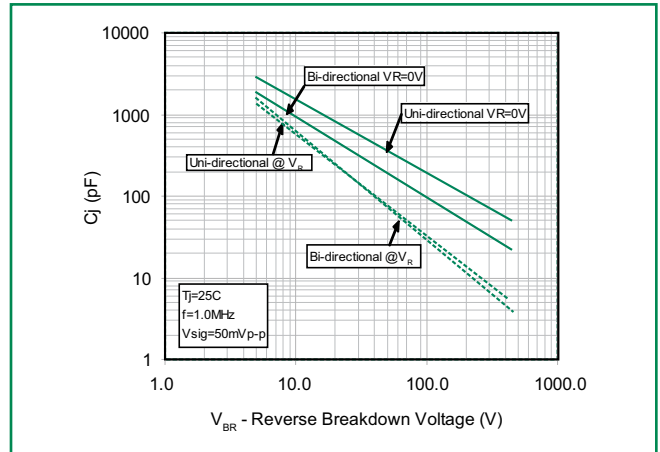

#### Figure 5 - Steady Pulse Derating Curve

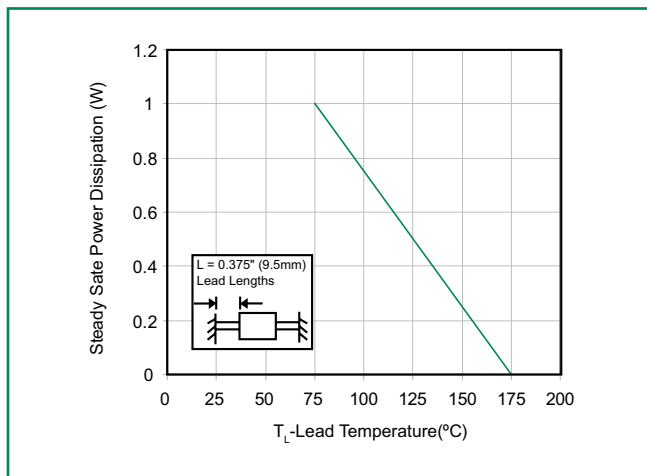

#### Figure 6 - Maximum Non-Repetitive Peak Forward Surge Current Uni-Directional Only

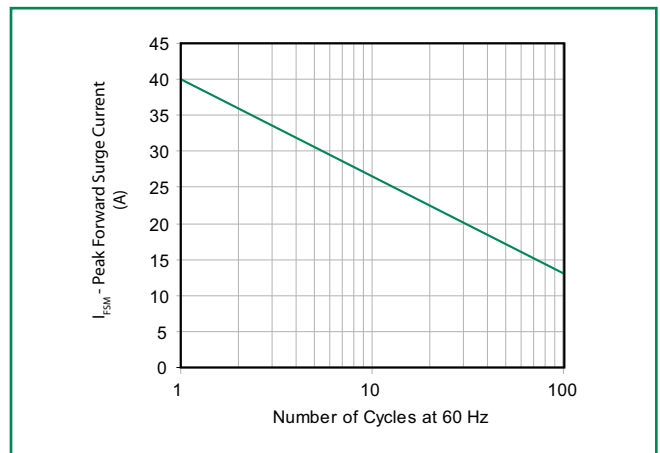

## Soldering Parameters

Reflow Condition		Lead-free assembly
Pre Heat	- Temperature Min ( $T_{s(min)}$ )	150°C
	- Temperature Max ( $T_{s(max)}$ )	200°C
	- Time (min to max) ( $t_s$ )	60 – 180 secs
Average ramp up rate (Liquidus Temp ( $T_L$ ) to peak)		3°C/second max
$T_{s(max)}$ to $T_L$ - Ramp-up Rate		3°C/second max
Reflow	- Temperature ( $T_L$ ) (Liquidus)	217°C
	- Time (min to max) ( $t_s$ )	60 – 150 seconds
Peak Temperature ( $T_p$ )		260 <sup>+0/-5</sup> °C
Time within 5°C of actual peak Temperature ( $t_p$ )		20 – 40 seconds
Ramp-down Rate		6°C/second max
Time 25°C to peak Temperature ( $T_p$ )		8 minutes Max.
Do not exceed		280°C

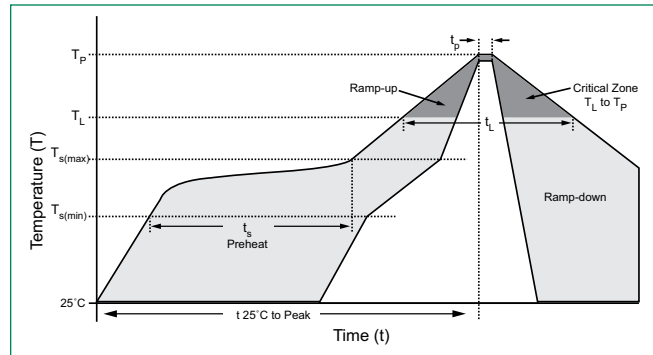

## Flow/Wave Soldering (Solder Dipping)

<b>Peak Temperature :</b>	260°C
<b>Dipping Time :</b>	5 seconds
<b>Soldering :</b>	1 time

## Physical Specifications

<b>Weight</b>	0.012oz., 0.3g
<b>Case</b>	JEDEC DO-204AL (DO-41) molded plastic body over passivated junction.
<b>Polarity</b>	Color band denotes the cathode except Bipolar.
<b>Terminal</b>	Matte Tin axial leads, solderable per JESD22-B102D.

## Environmental Specifications

<b>Temperature Cycle</b>	JESD22-A104
<b>Pressure Cooker</b>	JESD 22-A102
<b>High Temp. Storage</b>	JESD22-A103
<b>HTRB</b>	JESD22-A108
<b>Thermal Shock</b>	JESD22-A106

## Dimensions

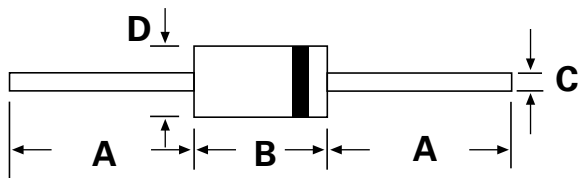

DO-204AL (DO-41)

Dimensions	Inches		Millimeters	
	Min	Max	Min	Max
A	1.000	-	25.40	-
B	0.160	0.205	4.10	5.20
C	0.028	0.034	0.71	0.86
D	0.080	0.107	2.00	2.70

### Part Numbering System

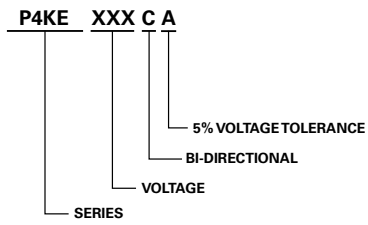

Option: Suffix B is for bulk packing.

### Part Marking System

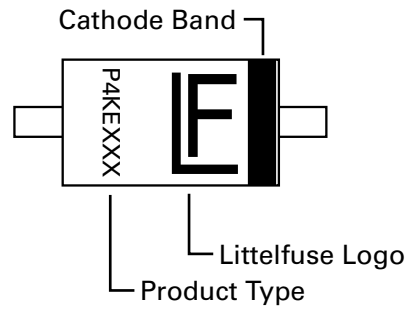

### Packaging

Part Number	Component Package	Quantity	Packaging Option	Packaging Specification
P4KExxxXX	DO-204AL	5000	Tape & Reel	EIA STD RS-296E
P4KExxxXXB	DO-204AL	500	BOX	Littelfuse Concord Packing Spec. DM-0016