

# Distinctive Characteristics

Each half of the rocker face is distinctly illuminated due to partitioned rocker construction and dual lamps.

Numerous lighting effects achievable by using white or clear rocker with colored filters or lamp covers, plus using different colors on each side of rocker.

Snap-in mounting allows fast, easy installation of switch into panel.

Stainless steel retaining clips provide secure mounting over a wide range of panel thicknesses.

Dual incandescent or neon lamps operate independently of each other.

Front panel relamping.

Stationary lamp sockets are independent of rocker actuation, protecting lamps from damage due to shock and vibration.

Switch contacts are rated at 10 amps 125V AC which makes these devices well-suited for various power switching applications.



Actual Size

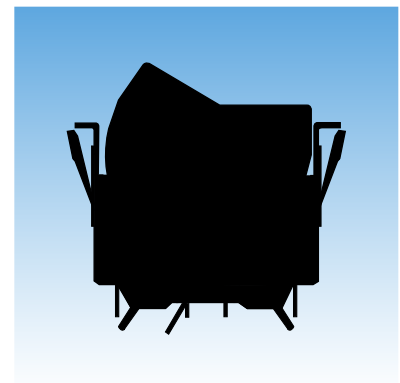

## General Specifications

### Electrical Capacity

**Resistive Load:** 10A @ 125V AC, 6A @ 250V AC, or 6A @ 30V DC  
**Inductive Load:** 5A @ 125V AC (P. F. @ .60)

### Other Ratings

**Contact Resistance:** 10 milliohms maximum  
**Insulation Resistance:** 200 megohms minimum @ 500V DC  
**Dielectric Strength:** 1,500V AC minimum for 1 minute minimum  
**Mechanical Life:** 30,000 operations minimum  
**Electrical Life:** 10,000 operations minimum  
**Nominal Operating Force:** 11.77N for maintained & 17.65N for momentary  
**Angle of Throw:** 34°

### Materials & Finishes

**Housing:** Steel with chrome plating  
**Movable Contacts:** Silver clad copper with silver plating  
**Stationary Contacts:** Copper with silver plating  
**Base:** Melamine  
**Common Terminal:** Copper with silver plating  
**End Terminals:** Brass with silver plating  
**Lamp Terminals:** Phosphor bronze with nickel plating

### Environmental Data

**Operating Temperature Range:** -20°C through +50°C (-4°F through +122°F)  
**Humidity:** 90 ~ 95% humidity for 96 hours @ 40°C (104°F)  
**Vibration:** 10 ~ 55Hz with peak-to-peak amplitude of 1.5mm traversing the frequency range & returning in 1 minute; 3 right angled directions for 2 hours  
**Shock:** 50G (490m/s<sup>2</sup>) acceleration (tested in 3 right angled directions, with 3 shocks in each direction)

### Installation

**Cap Installation Force:** 19.61N (4.41 lbf)  
**Soldering Time & Temperature:** Manual Soldering: See Profile A in Supplement section.

### Standards & Certifications

**UL & C-UL Recognized:**



All models recognized at 10A @ 125V AC & 6A @ 250V AC;  
 UL File No. WOYR2.E44145 & C-UL File No. WOYR8.E44145;  
 add "/U" to end of part number to order UL mark on switch & add "/C-UL" to end of part number to order C-UL mark on switch (equivalent to CSA certification).

### TYPICAL SWITCH ORDERING EXAMPLE

LW31 2 2 — H 4 C F — A

POLE	
2	DPDT

CIRCUITS			
	Up	Center	Down
2	ON	NONE	ON
3	ON	OFF	ON
5	ON	NONE	(ON)
8	(ON)	OFF	(ON)
9	ON	OFF	(ON)

( ) = Momentary

LAMPS	
Incandescent	
E	6-volt
F	12-volt
H	18-volt
K	24-volt
L	28-volt
Neon	
N	110-volt
Not suitable with green & blue	
Nonilluminated	
0	No Lamp

BEZEL	
No Code	No Bezel
A	Black
B	White
C	Red
D	Amber
E	Yellow
F	Green
G	Blue
H	Gray

ROCKER CAPS	
1	White without filters or lamp covers
2	White with filters
3	White with lamp covers
4	Clear with filters

LAMP COVER/ FILTER COLORS FOR UP POSITION	
0	No Cover/Filter
Lamp Cover	
C	Red
D	Amber
F	Green
Filter	
B	White
C	Red
D	Amber
E	Yellow
F	Green
G	Blue

LAMP COVER/ FILTER COLORS FOR DOWN POSITION	
0	No Cover/Filter
Lamp Cover	
C	Red
D	Amber
F	Green
Filter	
B	White
C	Red
D	Amber
E	Yellow
F	Green
G	Blue

#### DESCRIPTION FOR TYPICAL ORDERING EXAMPLE

LW3122-H4CF-A

Clear Rocker with  
Red Filter in Up Position and  
Green Filter in Down Position

DPDT  
ON-NONE-ON Circuit

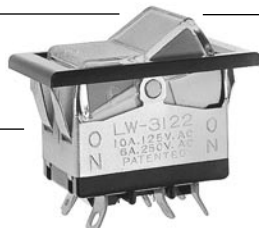







18-volt  
Incandescent Lamp  
Black Bezel

#### IMPORTANT:



Switches are supplied without UL & C-UL markings unless specified. Specific models & ratings noted on General Specifications page.

### POLES & CIRCUITS

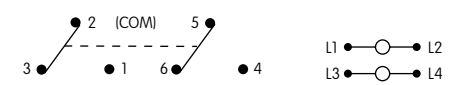
Pole	Model	Rocker Position ( ) = Momentary			Connected Terminals			Throw & Power/Lamp Schematics
		Up 	Center 	Down 	Up 	Center 	Down 	
DP	LW3122 LW3123 LW3125 LW3128 LW3129	ON ON ON (ON) ON	NONE OFF NONE OFF OFF	ON ON (ON) (ON) (ON)	2-3 5-6	OPEN	2-1 5-4	Notes: Terminal numbers are not actually on switch. Lamp circuit is isolated and requires an external power source.  DPDT 



### LAMP CODES & SPECIFICATIONS

Electrical specifications are determined at a basic temperature of 25°C. Lamp circuit is independent of switch operation.

For dimension drawing of lamps see Accessories & Hardware section.

For neon, if the source voltage is greater than rated voltage, a ballast resistor is required. The ballast resistor calculation and more lamp detail are shown in the Supplement section. Neon not for use with green lamp cover or blue and green filters.

#### Incandescent & Neon Lamps for Solid & Design Caps

AT602 Incandescent	AT602N Neon		<b>E</b>	<b>F</b>	<b>H</b>	<b>K</b>	<b>L</b>	<b>N</b>	
		Voltage	6V AC	12V AC	18V AC	24V AC	28V AC	110V AC	
		Current	80mA	50mA	35mA	25mA	22mA	1.5mA	
		MSCP	.159	.215	.398	.215	.247	NA	
		Endurance	2,000 Average					15,000 Average	
		Ambient Temperature Range	-20°C ~ +50°C					-20°C ~ +50°C	
Recommended Resistor for Neon: 33K ohms for 110V AC; 100K ohms for 220V AC									
T-1½ Pilot Slide Base		<b>0</b>	<b>No Lamp</b> Code 0 indicates that no lamp is used.						

### ROCKER CAPS, LAMP COVER & FILTER

**1** AT420B White Rocker without Filters or Lamp Covers

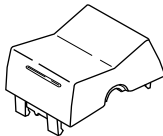

**2** AT420B White Rocker with Filters

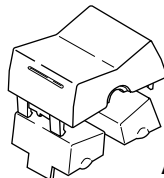

AT421

**3** AT420B White Rocker with Lamp Covers

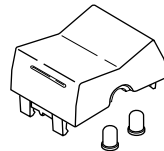

AT416

**4** AT420J Clear Rocker with Filters

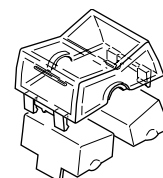

AT421

Rocker Cap Material: Polycarbonate

Finish: Glossy

Indicate the lamp cover or filter color desired in both the up and down positions.

**C** Red  
**D** Amber  
**F** Green

AT416 Lamp Cover



Material: Silicon Rubber

**B** White  
**C** Red  
**D** Amber  
**E** Yellow  
**F** Green  
**G** Blue

AT421 Filter

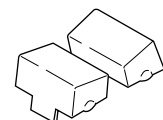

Material: Polycarbonate

### BEZEL & BEZEL COLORS

#### AT206 Bezel & Color Codes

<b>No Code</b> No Bezel	<b>B</b> White	<b>D</b> Amber	<b>F</b> Green	<b>H</b> Gray
<b>A</b> Black	<b>C</b> Red	<b>E</b> Yellow	<b>G</b> Blue	Material: Polycarbonate

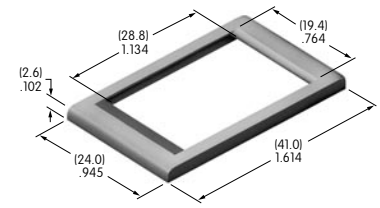

### TYPICAL SWITCH DIMENSIONS

#### Solder Lug • Without Bezel

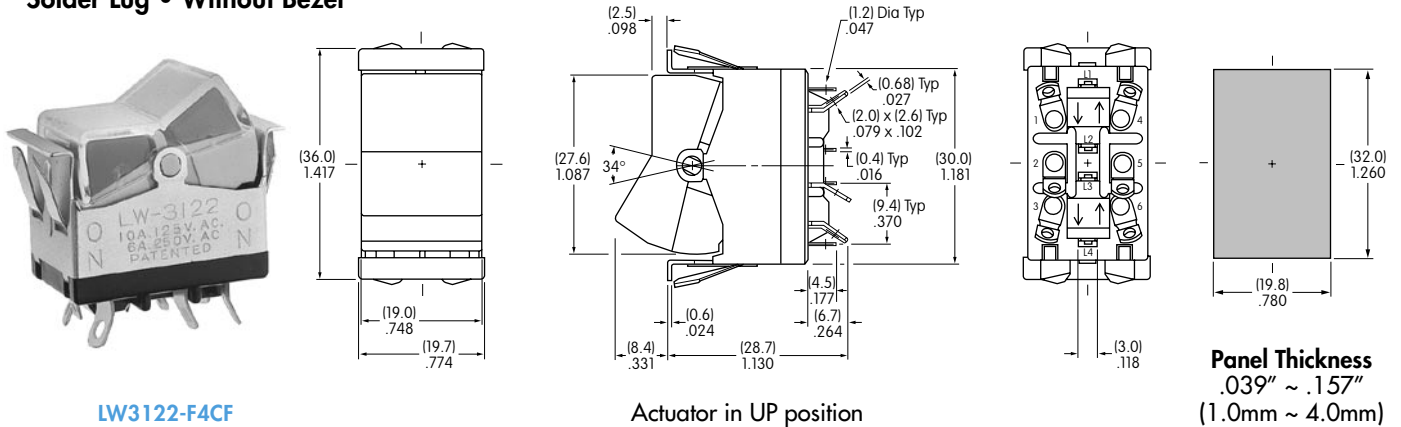

LW3122-F4CF

#### Solder Lug • With Bezel

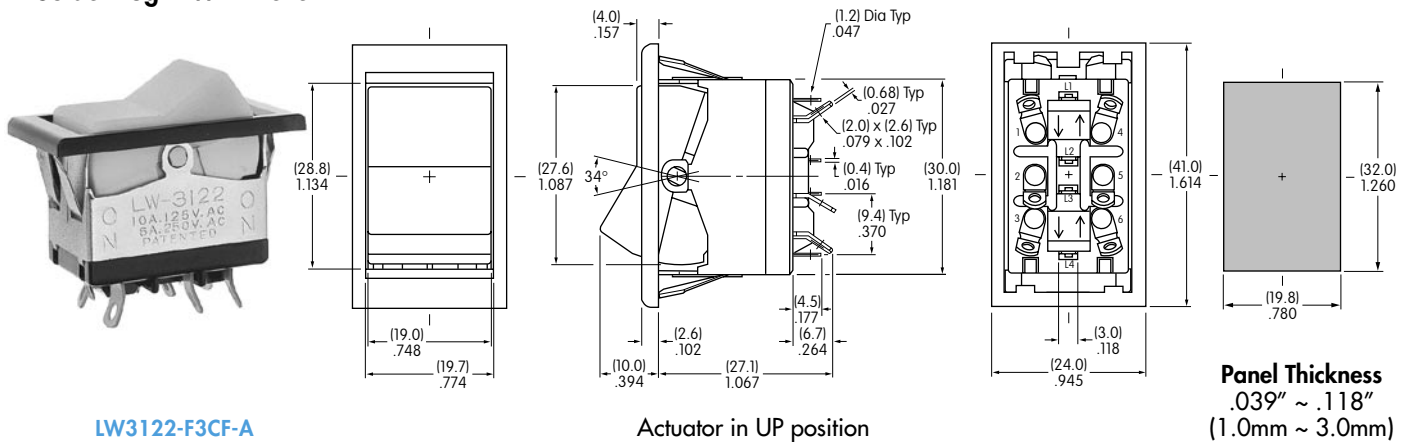

LW3122-F3CF-A

### OPTIONAL ACCESSORY

#### AT107 Lamp Extractor

Lamps can be changed without removing the switch from the panel. AT107 assists in removing lamps from the switch.

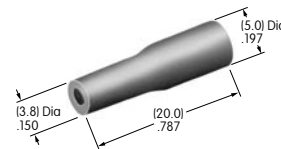

### LEGENDS

Inscriptions can be placed on the rocker or filter.

Details regarding screen printing and engraving may be obtained from the factory.