

Distinctive Characteristics

Combination bezel-barrier is an integral part of the switch and prevents accidental actuation.

Unique thermoplastic elastomer seal inside caps plus rolled sleeve of nitrile butadiene rubber at joining of housing and inner case, all for added protection to interior mechanism.

Dust and oil tight as well as splashproof panel seal models qualify to IP65 of IEC60529 Standards (similar to NEMA 4 and 13). Panel seal models provided with exterior o-ring.

Distinctive design of snap-action contacts for shock resistance, long life, and sensitive actuation.

High density design to give behind panel depth of less than one inch.

Terminals are epoxy sealed to lock out flux, dust, solvents, and other contaminants.

Latchdown for indication of circuit status, plus audible, tactile feedback with smooth, responsive operation.

Illuminated models available and shown in the Illuminated Pushbutton section.

Matching indicators available and shown at the end of Section M.

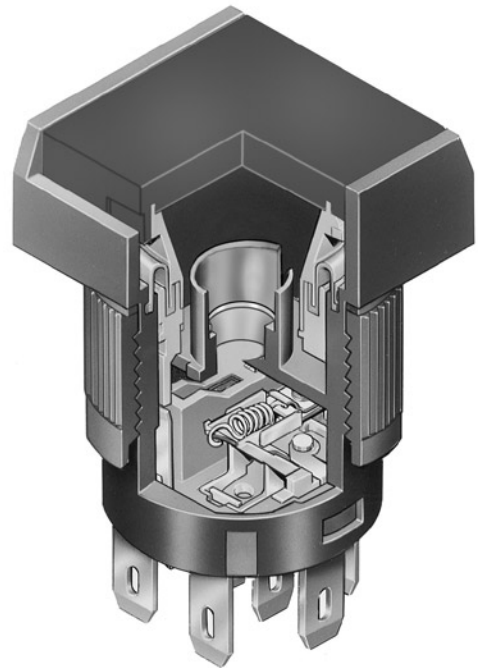

Actual Size

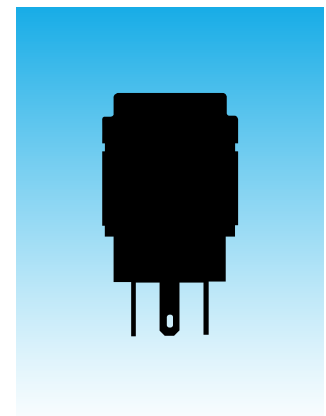

General Specifications

Electrical Capacity (Resistive Load)

Power Level (silver): 3A @ 125V AC or 3A @ 250V AC or 3A @ 30V DC
Logic Level (gold): 0.4VA maximum @ 28V AC/DC maximum
 (Applicable Range 0.1mA ~ 0.1A @ 20mV ~ 28V)
 Note: Find additional explanation of operating range in Supplement section.

Other Ratings

Contact Resistance: 50 milliohms maximum for silver; 100 milliohms maximum for gold
Insulation Resistance: 200 megohms minimum @ 500V DC
Dielectric Strength: 1,000V AC minimum between contacts for 1 minute minimum;
 1,500V AC minimum between contacts & case for 1 minute minimum
Mechanical Life: 1,000,000 operations minimum for momentary circuit
 200,000 operations minimum for maintained circuit
Electrical Life: 100,000 operations minimum
Nominal Operating Force: Single pole: 1.47N for nonsealed; 1.67N for sealed
 Double pole: 2.75N for nonsealed; 2.94N for sealed
Contact Timing: Nonshorting (break-before-make)
Travel: Pretravel .059" (1.5mm); Overtravel .059" (1.5mm); Total Travel .118" (3.0mm)

Materials & Finishes

Housing/Bezel: Glass fiber reinforced polyamide (UL94V-0)
Snap-in Frame: Stainless steel
Base: Diallyl phthalate resin (UL94V-0)
Movable Contactor: Phosphor bronze with silver or gold plating
Movable Contacts: Silver alloy with silver plating or brass with gold plating
Stationary Contacts: Silver alloy or copper with gold plating
Terminals: Phosphor bronze with tin plating

Environmental Data

Operating Temp Range: -25°C through +70°C (-13°F through +158°F)
Humidity: 90 ~ 95% humidity for 96 hours @ 40°C (104°F)
Vibration: 10 ~ 55Hz with peak-to-peak amplitude of 1.5mm traversing the frequency range & returning in 1 minute; 3 right angled directions for 2 hours
Shock: 50G (490m/s²) acceleration (tested in 6 right angled directions, with 5 shocks in each direction)
Sealing: IP65 of IEC60529 standard for panel seal models

Installation

Mounting Torque: 0.785Nm (6.95 lb•in) maximum
Soldering Time & Temperature: Manual Soldering: See Profile A in Supplement section.

Standards & Certifications

Flammability Standards: UL94V-0 housing & base
UL & C-UL Recognized: All solder lug models recognized at 3A @ 125/250V AC or 0.4VA @ 28V AC/DC maximum; UL File No. WOYR2.E44145; add "/U" to end of part number to order UL mark on switch; C-UL File No. WOYR8.E44145; add "/C-UL" to end of part number to order C-UL mark on switch.
CSA Certified: All solder lug models certified at 3A @ 125/250V AC or 0.4VA @ 28V AC/DC maximum; CSA File Nos. 023535-0-000; add "/C" to end of part number to order CSA mark on switch.



TYPICAL SWITCH ORDERING EXAMPLE

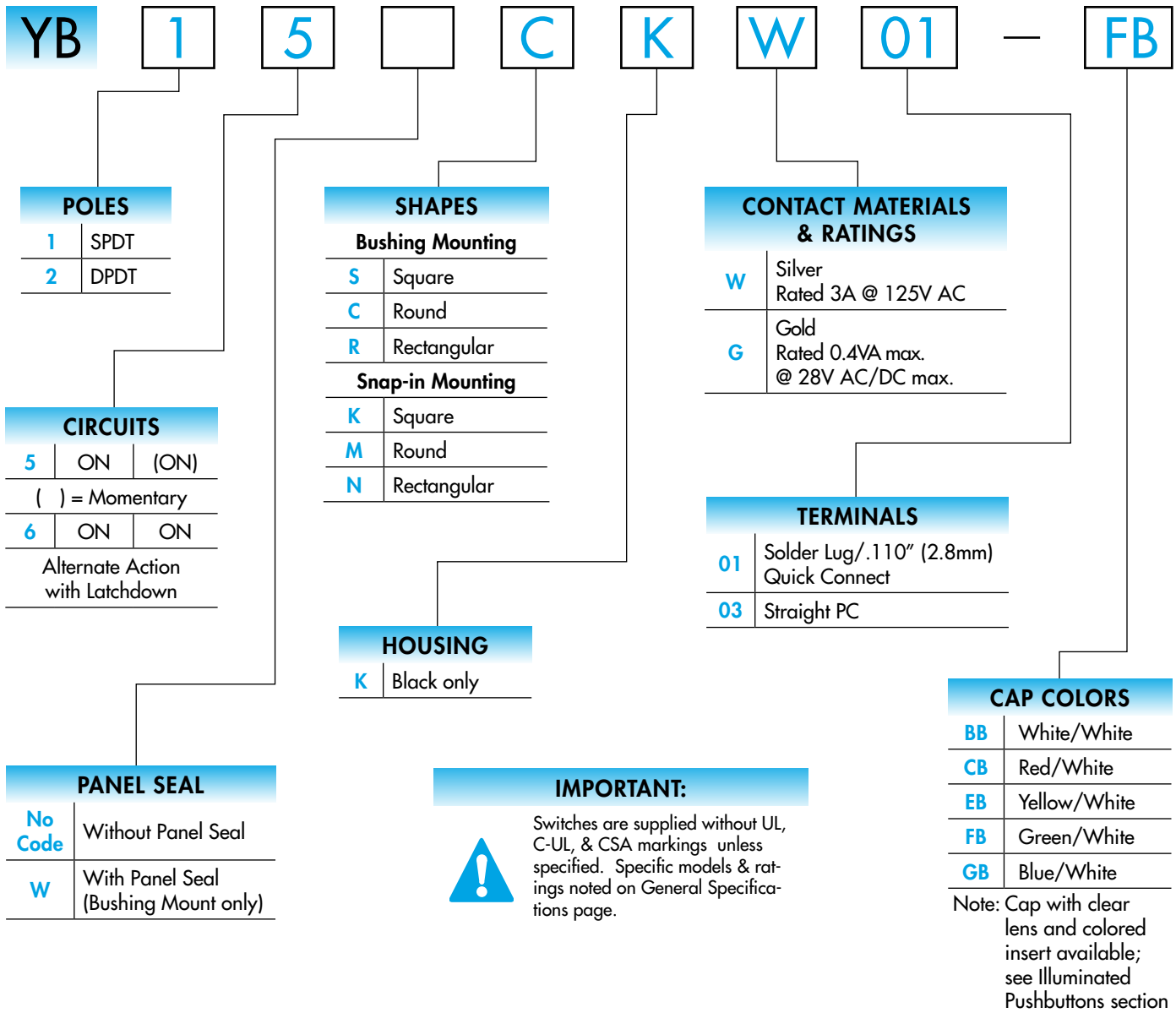





DESCRIPTION FOR TYPICAL ORDERING EXAMPLE

YB15CKW01-FB

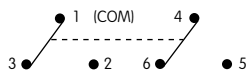

POLES & CIRCUITS

Pole	Model	Plunger Position () = Momentary		Connected Terminals		Throw & Schematics
		Normal 	Down 	Normal 	Down 	
SP	YB15 *YB16	ON ON	(ON) ON	1-3	1-2	SPDT 
DP	YB25 *YB26	ON ON	(ON) ON	1-3 4-6	1-2 4-5	DPDT 

* When in latched position for the alternate circuit, cap position is .020" (0.5mm) above the built-in bezel.

PANEL SEAL

No Code

Without Panel Seal

Bushing
Mounting

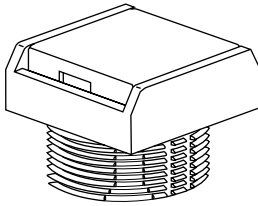

Supplied with
mounting nut.

Snap-in
Mounting

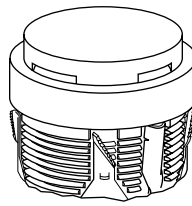

W

With Panel Seal

Bushing
Mounting
only

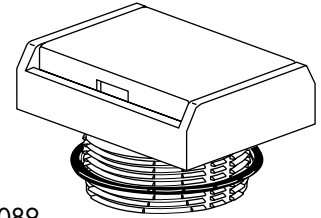

Supplied with
mounting nut
and o-ring AT089.

SHAPES & MOUNTING TYPES

Bushing Mounting

Snap-in Mounting

S

Square

C

Round

R

Rectangular

K

Square

M

Round

N

Rectangular

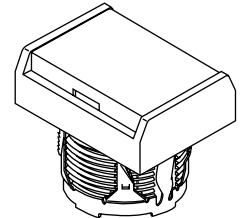
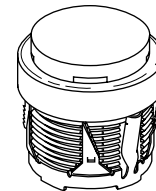
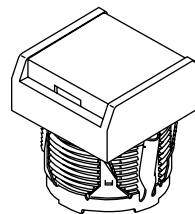
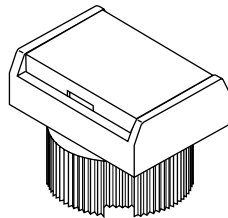
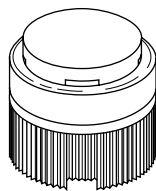
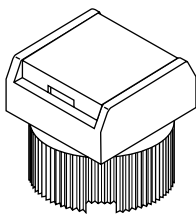

Bezel-barrier is an integral part of the switch body.

HOUSING

K

Black

Housing available in black only. The 1-piece body and bezel-barrier have a matte finish.

CONTACT MATERIALS & RATINGS

W

Silver Contacts

Power Level

3A @ 125/250V AC

G

Gold Contacts

Logic Level

0.4VA max. @ 28V AC/DC max.

Complete explanation of operating range in Supplement section.

TERMINALS

01 Solder Lug/
.110" (2.8mm) Quick Connect

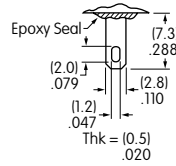

03 Straight PC

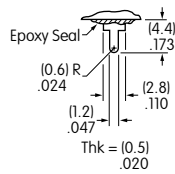

Single Pole

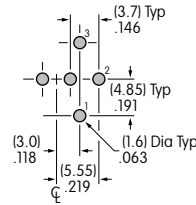

Double Pole

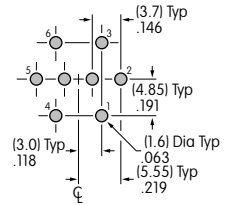

CAPS & COLORS

Colors Available:

BB White/
White

CB Red/
White

EB Yellow/
White

FB Green/
White

GB Blue/
White

AT3002
Round

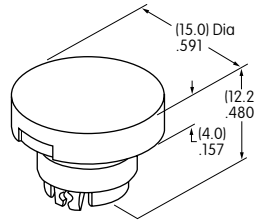

AT3001
Square

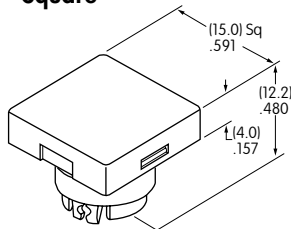

AT3003
Rectangular

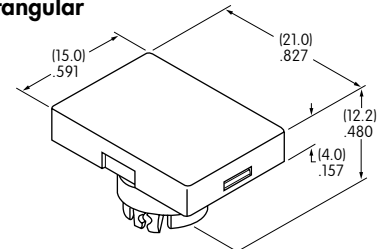

Materials:

Lens & Insert: Polycarbonate

Seal/Filter: Thermoplastic Elastomer

TYPICAL SWITCH DIMENSIONS

Square • Bushing Mounting

Single & Double Pole

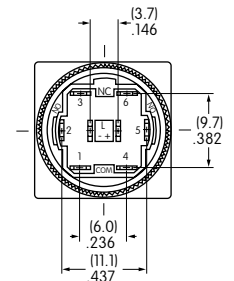
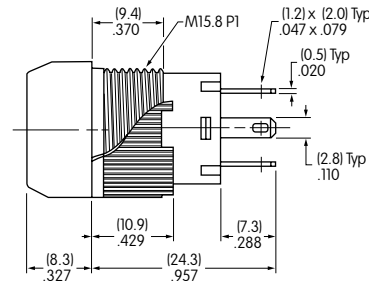
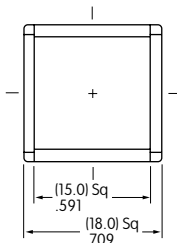

YB15SKW01-CB

Single pole models do not have terminals 4, 5, & 6.

TYPICAL SWITCH DIMENSIONS

Round • Panel Seal

Single & Double Pole

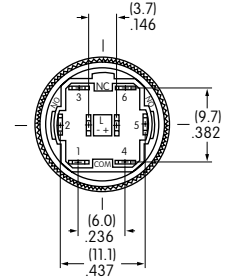
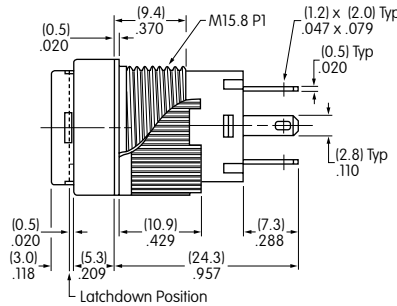
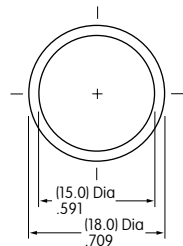

YB25WCKW01-EB

Single pole models do not have terminals 4, 5, & 6.

Rectangular • Snap-in Mounting

Single & Double Pole

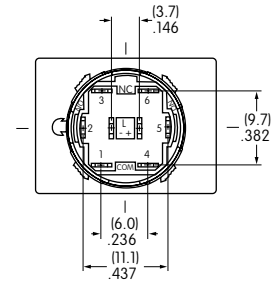
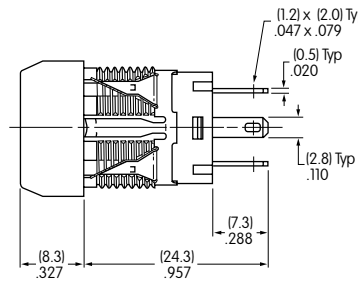
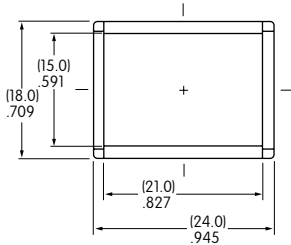

YB15NKW01-CB

Single pole models do not have terminals 4, 5, & 6.

PANEL THICKNESS & CUTOUTS

Bushing & Panel Seal Mount

Panel Thickness
.020" ~ .197"
(0.5mm ~ 5.0mm)

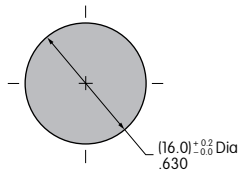

Panel Thickness
.039" ~ .138"
(1.0mm ~ 3.5mm)

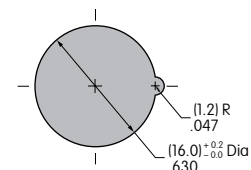

AT106
Socket Wrench
for Bushing Mounting

Material: Aluminum
with black alumite finish

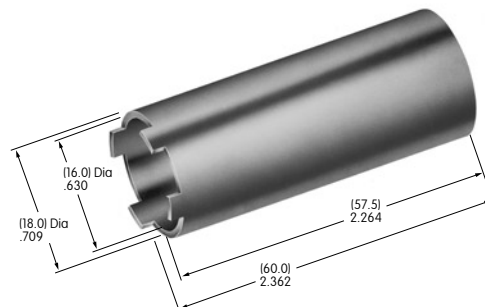

Note: Overtightening the mounting nut AT092 may damage the switch housing.

OPTIONAL ACCESSORIES

Dust Covers and Protective Guards reduce depth of switch behind panel by .047" (1.2mm).

Panel Thickness Range with Dust Cover or Protective Guards:

Bushing Mounting
.020" ~ .150" (0.5mm ~ 3.8mm)

Snap-in Mounting
.020" ~ .091" (0.5mm ~ 2.3mm)

Panel Seal
.020" ~ .118" (0.5mm ~ 3.0mm)

AT4115 Dust Cover for Snap-in or Bushing Mount

AT4115 Splash Cover and AT541 O-ring for Bushing Mount

Materials:
Lid: Polyvinyl Chloride
Base: Polyamide
O-ring: Nitrile butadiene rubber

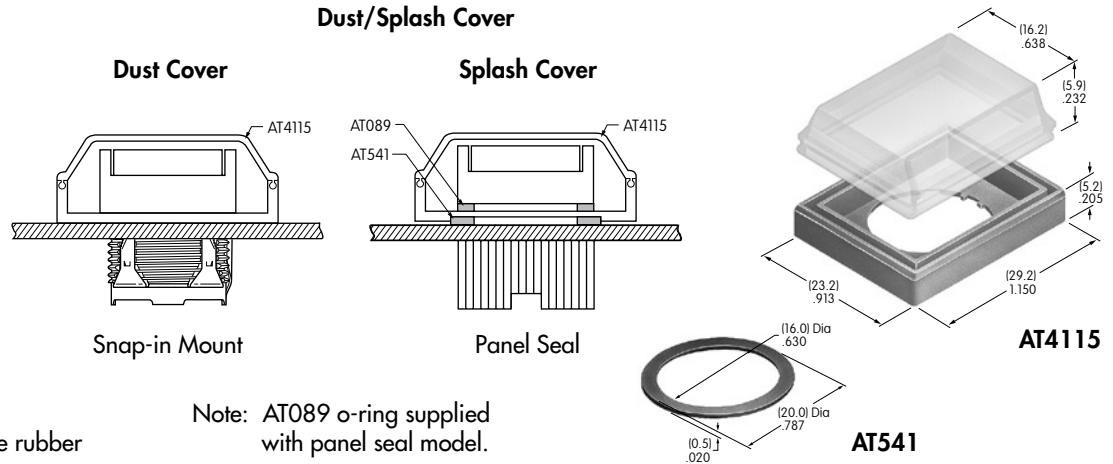

AT4072 Protective Guard
Opens 90°
Closes manually

Materials:
Lid: Polycarbonate
Base: Glass Fiber Reinforced Polycarbonate

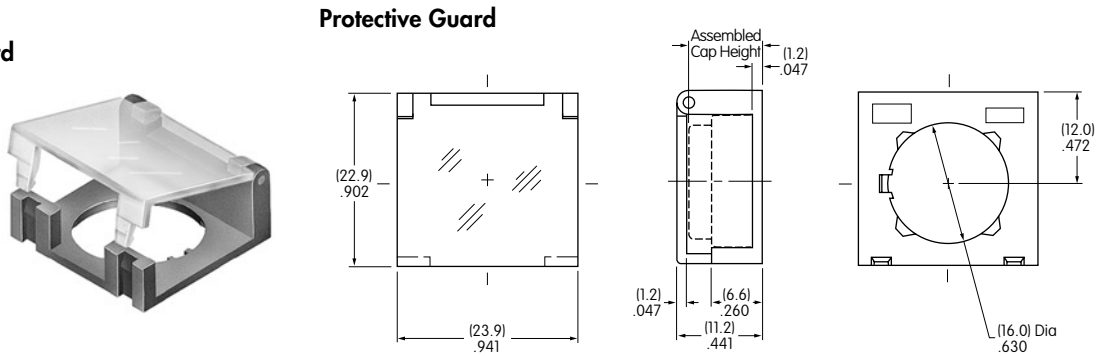

AT4175 Spring Loaded Protective Guard
Opens 180°
Closes automatically

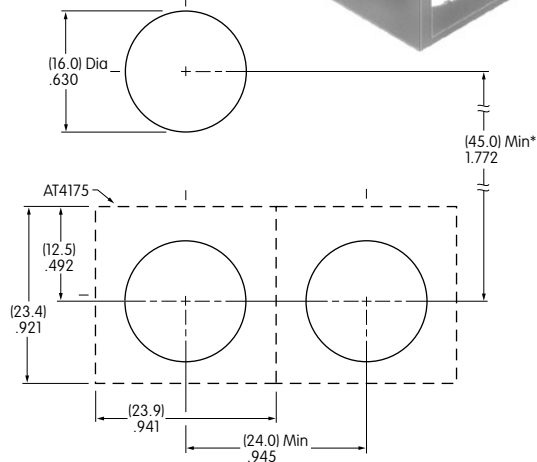

Spring Loaded Protective Guard

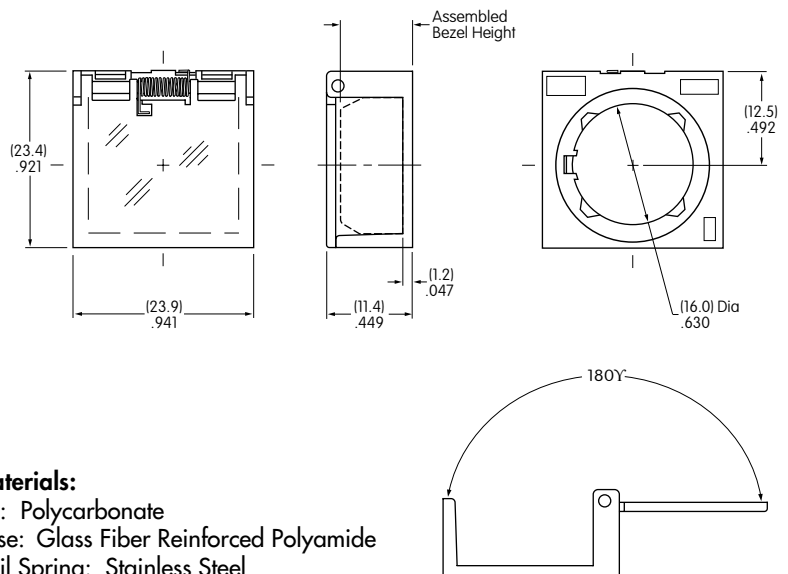

Materials:
Lid: Polycarbonate
Base: Glass Fiber Reinforced Polyamide
Coil Spring: Stainless Steel

* Minimum dimension allows opening of cover to 180°

LEGENDS

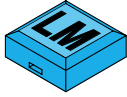

Easily create and submit your own legends using our new on-line Legend Maker.

Visit www.nkkswitches.com

For other legend support options, customers may either contact the factory and request the YB Legend Packet, or utilize the general information and basic specifications presented below.

Suggested Printable Area for YB Lens

Recommended Methods: Laser Etch on clear lens; Screen Print or Pad Print on lens.
Epoxy based ink is recommended.

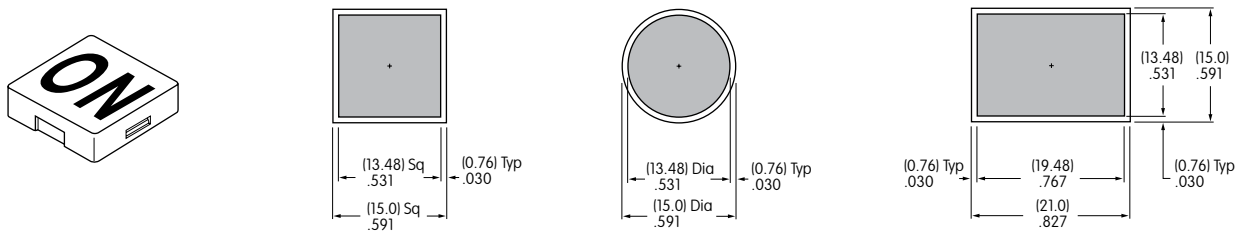

Shaded Areas Are Printable Areas

Additional Methods

Additional methods for legends are engraving the lens and laser printing on film inserts. Maximum depth for engraving is .012" (0.3 mm) on the cap lens. Enamel paint is recommended to fill the engraved area.