

Small signal Schotky diodes

Main product characteristics

I_F	300 mA
V_{RRM}	30 V
C (typ)	14 pF
T_j (max)	150° C

Features and benefits

- Very low conduction losses
- Negligible switching losses
- Low forward and reverse recovery times
- Extremely fast switching
- Surface mount device
- Low capacitance diode

Description

The BAT30 series uses 30 V Schotky barrier diodes encapsulated in a wide range of packages such as SOD-323, SOD-523, SOT-23, SOT-323, or SOT-666. This device is specially suited for switching mode applications needing low forward voltage drop diodes.

Order codes

Part Number	Marking
BAT30FILM	B30
BAT30SFILM	S30
BAT30CFILM	C30
BAT30AFILM	A30
BAT30WFILM	B30
BAT30SWFILM	S30
BAT30CWFILM	C30
BAT30AWFILM	A30
BAT30JFILM	30
BAT30KFILM	30
BAT30-07P6FILM	P3
BAT30-09P6FILM	Q3

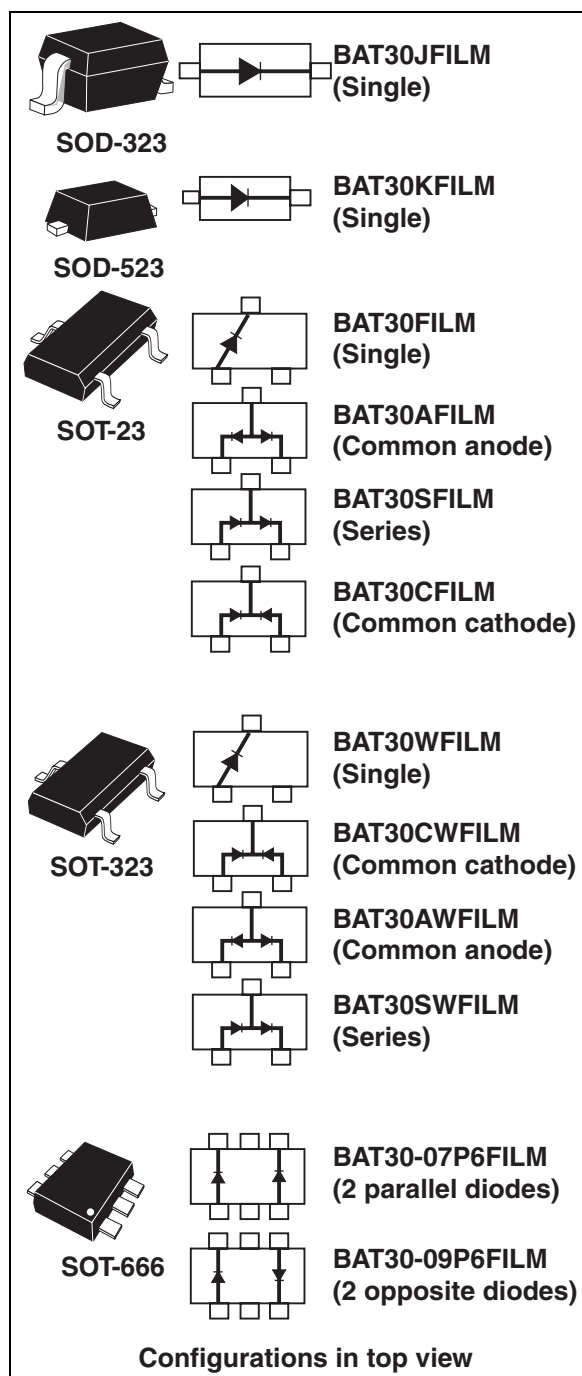

1 Characteristics

Table 1. Absolute ratings (limiting values at $T_j = 25^\circ\text{C}$, unless otherwise specified)

Symbol	Parameter	Value	Unit
V_{RRM}	Repetitive peak reverse voltage	30	V
I_F	Continuous forward current	300	mA
I_{FSM}	Surge non repetitive forward current	$t_p = 10\text{ ms}$ Sinusoidal	A
T_{stg}	Storage temperature range	-65 to +150	$^\circ\text{C}$
T_j	Maximum operating junction temperature ⁽¹⁾	150	$^\circ\text{C}$
T_L	Maximum soldering temperature	260	$^\circ\text{C}$

1. Pulse test: $t_p = 5\text{ ms}$, $\delta < 2\%$

Table 2. Thermal parameters

Symbol	Parameter	Value	Unit
$R_{th(j-a)}$	Junction to ambient ⁽¹⁾	SOT-23	500
		SOT-323, SOD-323,	550
		SOD-523, SOT-666	600
			$^\circ\text{C/W}$

1. On epoxy printed circuit board with recommended pad layout

Table 3. Static electrical characteristics

Symbol	Parameter	Test conditions	Min.	Typ	Max.	Unit
$I_R^{(1)}$	Reverse leakage current	$T_j = 25^\circ\text{C}$	$V_R = 5\text{ V}$			0.5
			$V_R = 10\text{ V}$			1
			$V_R = 25\text{ V}$		0.65	3
			$V_R = 30\text{ V}$			5
		$T_j = 70^\circ\text{C}$	$V_R = 10\text{ V}$		7	20
$T_j = 85^\circ\text{C}$		18		50		
$V_F^{(2)}$	Forward voltage drop	$T_j = 25^\circ\text{C}$	$I_F = 0.1\text{ mA}$			240
			$I_F = 1\text{ mA}$			300
			$I_F = 10\text{ mA}$			375
			$I_F = 30\text{ mA}$			430
			$I_F = 100\text{ mA}$			500
			$I_F = 200\text{ mA}$			580
			$I_F = 300\text{ mA}$		530	
					mV	

1. Pulse test: $t_p = 5\text{ ms}$, $\delta < 2\%$

2. Pulse test: $t_p = 380\text{ }\mu\text{s}$, $\delta < 2\%$

Table 4. Dynamic characteristics

Symbol	Parameter	Test conditions	Min.	Typ	Max.	Unit
C	Diode capacitance	$V_R = 0\text{ V}, F = 1\text{ MHz}$		22		pF
		$V_R = 1\text{ V}, F = 1\text{ MHz}$		14		
		$V_R = 10\text{ V}, F = 1\text{ MHz}$		6		

Figure 1. Power dissipation versus average forward current

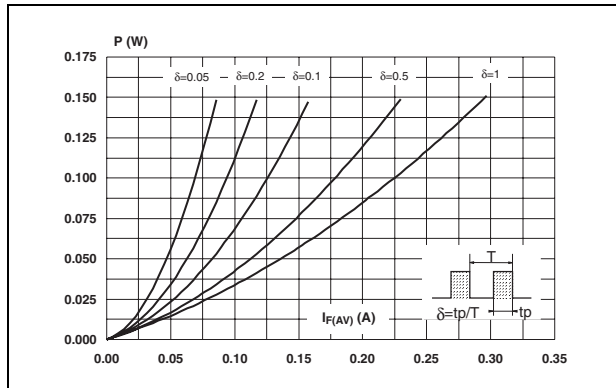

Figure 2. Average forward current versus ambient temperature (delta = 1)

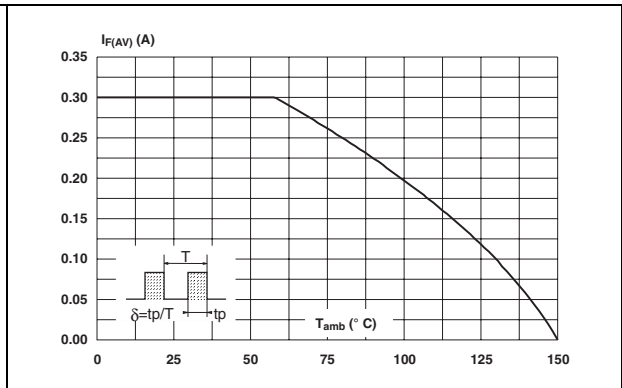

Figure 3. Relative variation of thermal impedance junction to ambient versus pulse duration (SOT-23)

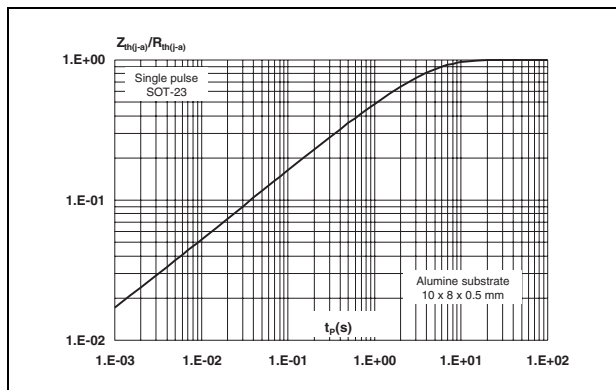

Figure 4. Relative variation of thermal impedance junction to ambient versus pulse duration (SOT-323 / SOD-323)

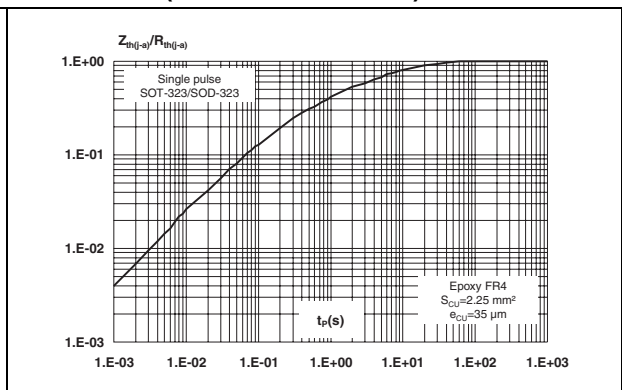

Figure 5. Relative variation of thermal impedance junction to ambient versus pulse duration (SOT-666)

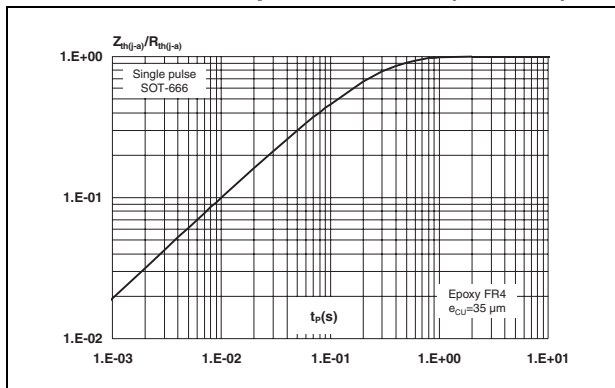

Figure 6. Relative variation of thermal impedance junction to ambient versus pulse duration (SOD-523)

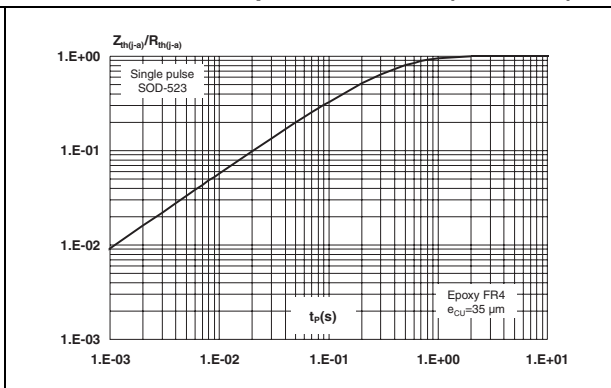

Figure 7. Relative variation of thermal impedance junction to ambient versus pulse duration (SOD-323)

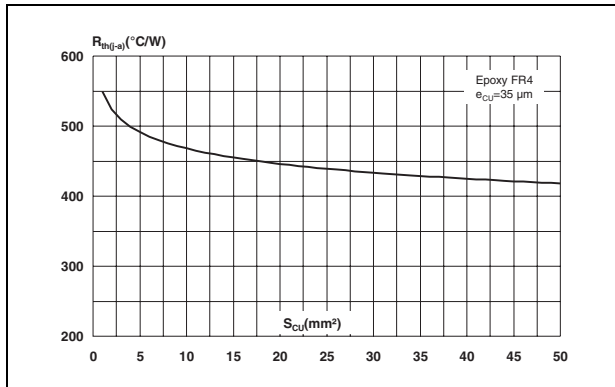

Figure 8. Leakage current versus reverse applied voltage (typical values)

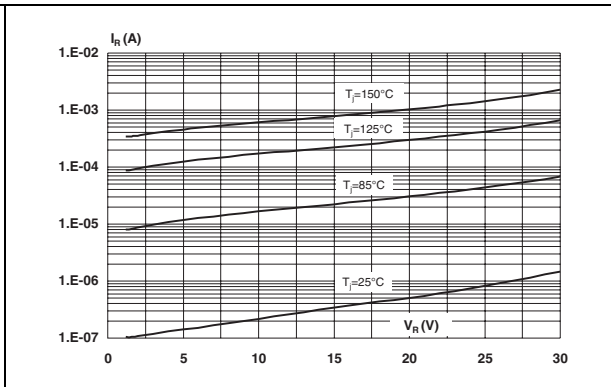

Figure 9. Relative variation of reverse leakage current versus junction temperature (typical values)

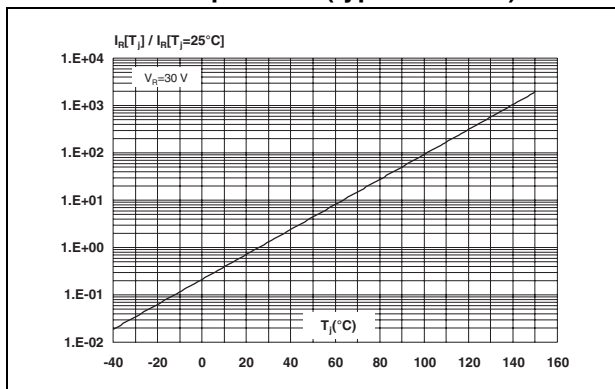

Figure 10. Junction capacitance versus reverse applied voltage (typical values)

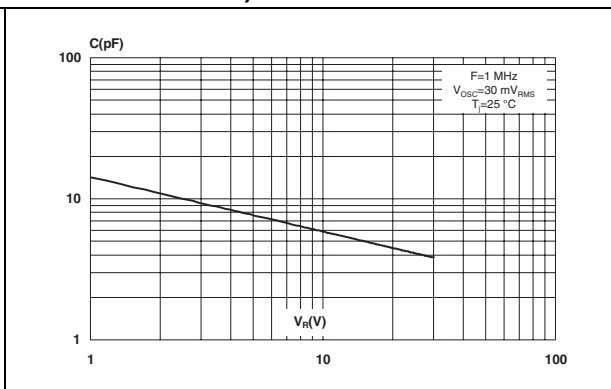

Figure 11. Forward voltage drop versus forward current (typical values)

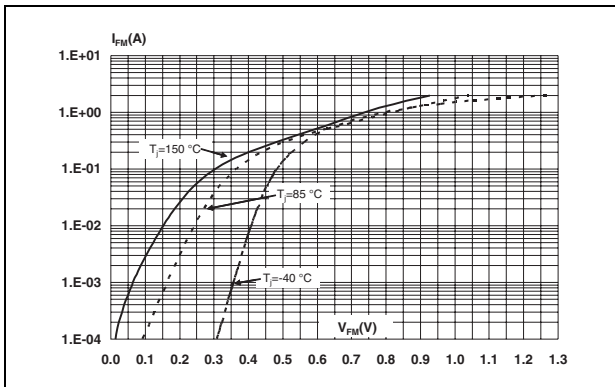
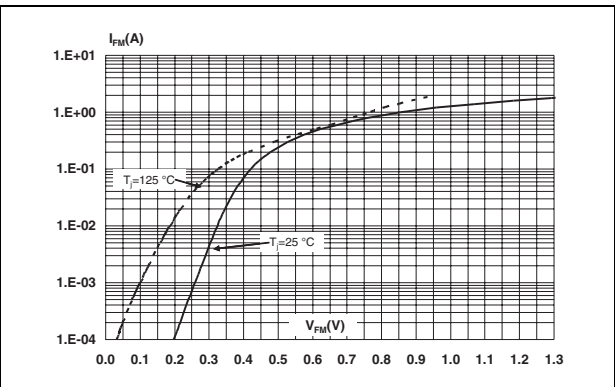
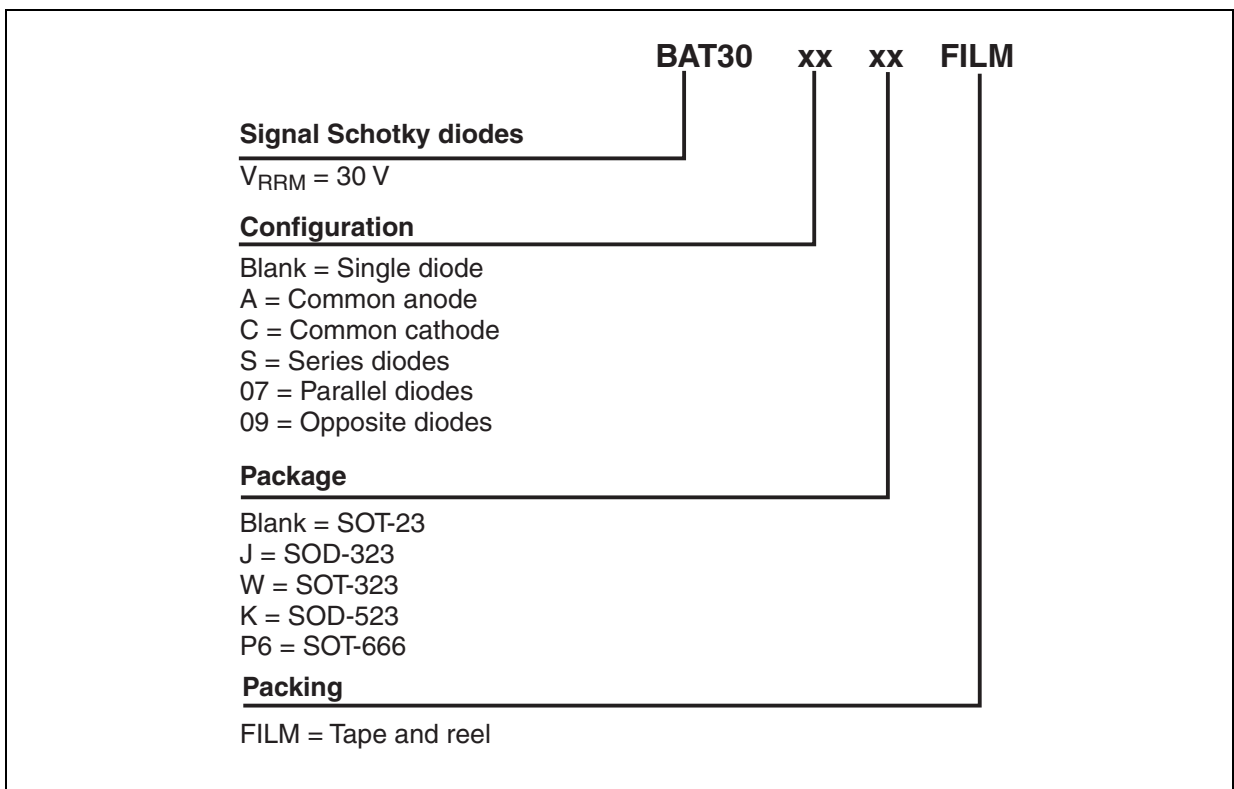

Figure 12. Forward voltage drop versus forward current (typical values)



2 Ordering information scheme



3 Package information

Epoxy meets UL94, V0

Table 5. SOD-323 dimensions

Ref.	Dimensions			
	Millimeters		Inches	
	Min.	Max.	Min.	Max.
A		1.17		0.046
A1	0	0.1	0	0.004
b	0.25	0.44	0.01	0.017
c	0.1	0.25	0.004	0.01
D	1.52	1.8	0.06	0.071
E	1.11	1.45	0.044	0.057
H	2.3	2.7	0.09	0.106
L	0.1	0.46	0.004	0.02
Q1	0.1	0.41	0.004	0.016

Figure 13. SOD-323 footprint (dimensions in mm)

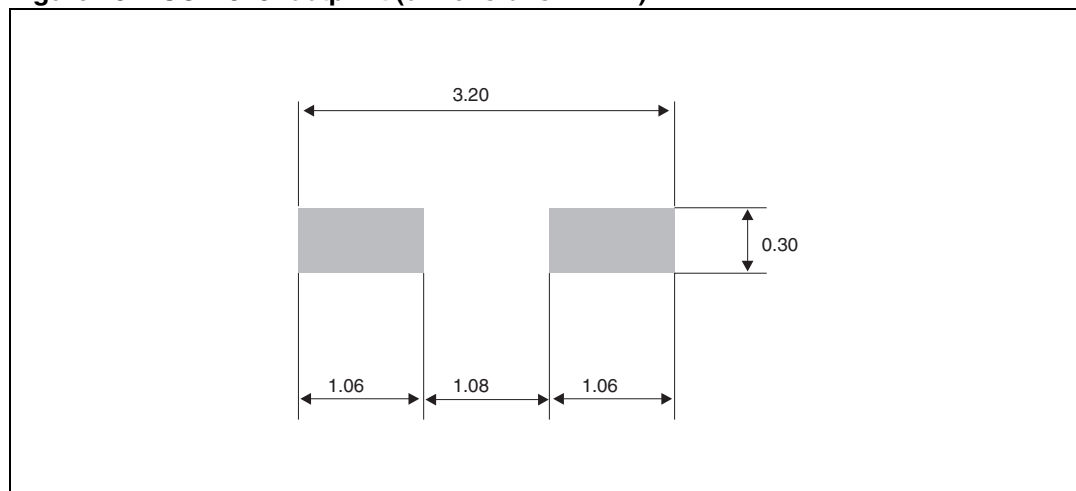

Table 6. SOD-523 dimensions

Ref.	Dimensions					
	Millimeters			Inches		
	Min.	Typ.	Max.	Min.	Typ.	Max.
A	0.50	0.60	0.70	0.020	0.024	0.028
E	1.50	1.60	1.70	0.059	0.063	0.067
E1	1.10	1.20	1.30	0.043	0.047	0.051
D	0.70	0.80	0.90	0.028	0.031	0.035
b	0.25		0.35	0.010		0.014
c	0.07		0.20	0.003		0.008
L	0.15	0.20	0.25	0.006	0.008	0.010
L1	0.10		0.20	0.004		0.008

Figure 14. SOD-523 footprint (dimensions in mm)

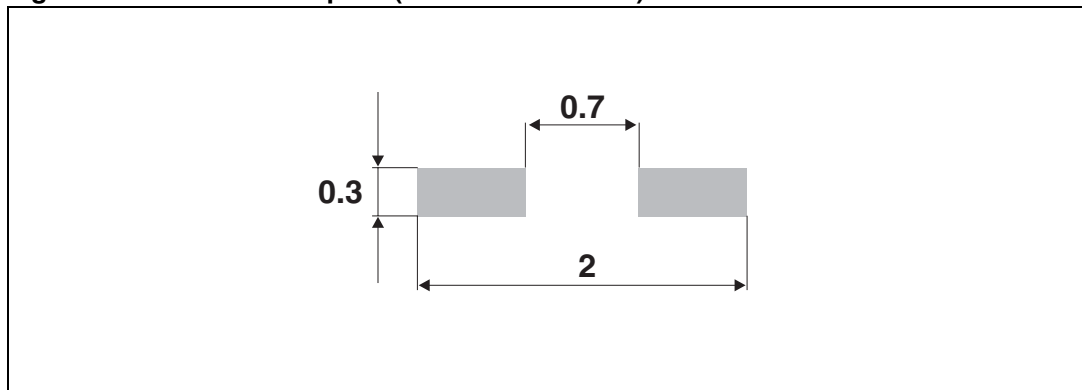

Table 7. SOT-23 dimensions

Ref.	Dimensions			
	Millimeters		Inches	
	Min.	Max.	Min.	Max.
A	0.89	1.4	0.035	0.055
A1	0	0.1	0	0.004
B	0.3	0.51	0.012	0.02
c	0.085	0.18	0.003	0.007
D	2.75	3.04	0.108	0.12
e	0.85	1.05	0.033	0.041
e1	1.7	2.1	0.067	0.083
E	1.2	1.6	0.047	0.063
H	2.1	2.75	0.083	0.108
L	0.6 typ.		0.024 typ.	
S	0.35	0.65	0.014	0.026

Figure 15. SOT-23 footprint (dimensions in mm)

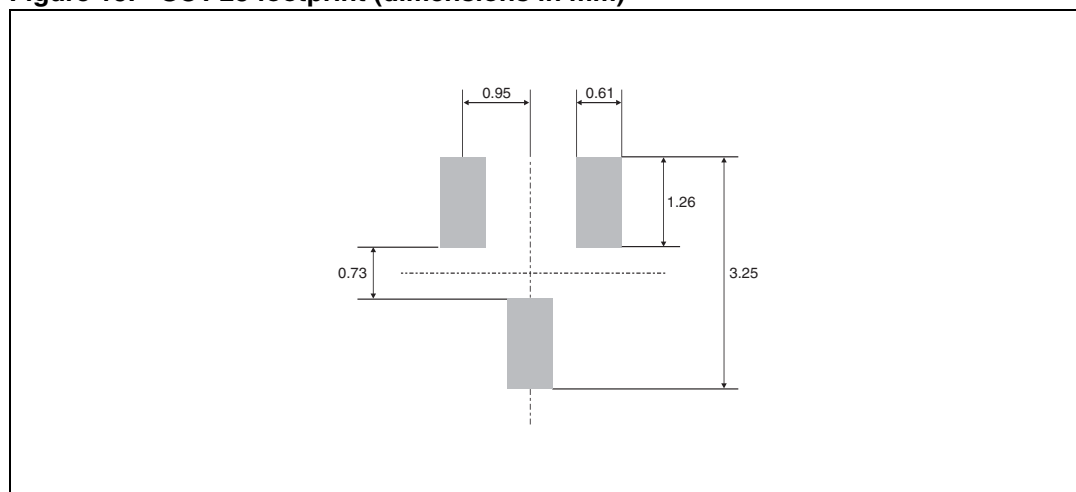

Table 8. SOT-323 dimensions

Ref.	Dimensions					
	Millimeters			Inches		
	Min.	Typ.	Max.	Min.	Typ.	Max.
A	0.8		1.1	0.031		0.043
A1	0.0		0.1	0.0		0.004
b	0.25		0.4	0.010		0.016
c	0.1		0.26	0.004		0.010
D	1.8	2.0	2.2	0.071	0.079	0.086
E	1.15	1.25	1.35	0.045	0.049	0.053
e		0.65			0.026	
H	1.8	2.1	2.4	0.071	0.083	0.094
L	0.1	0.2	0.3	0.004	0.008	0.012
q	0		30°	0		30°

Figure 16. SOT-323 footprint (dimensions in mm)

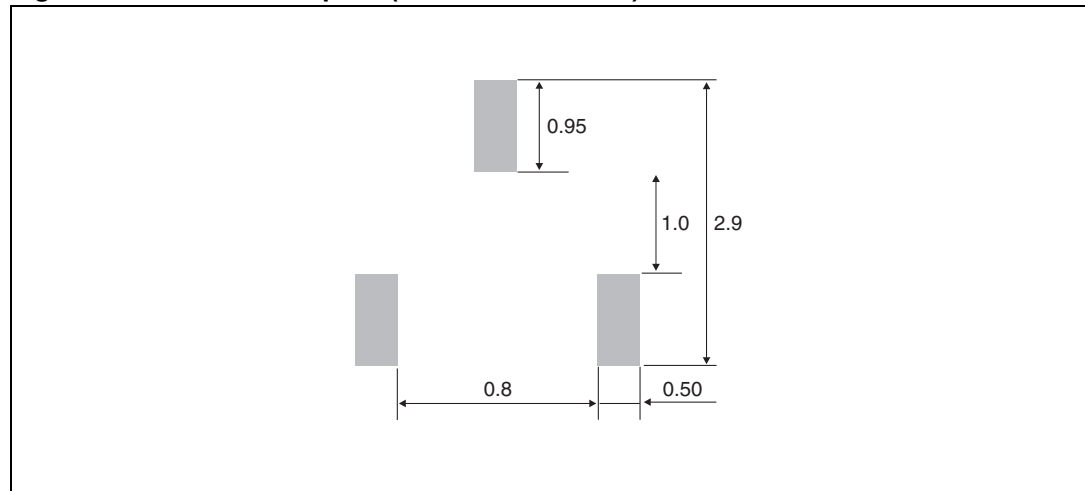
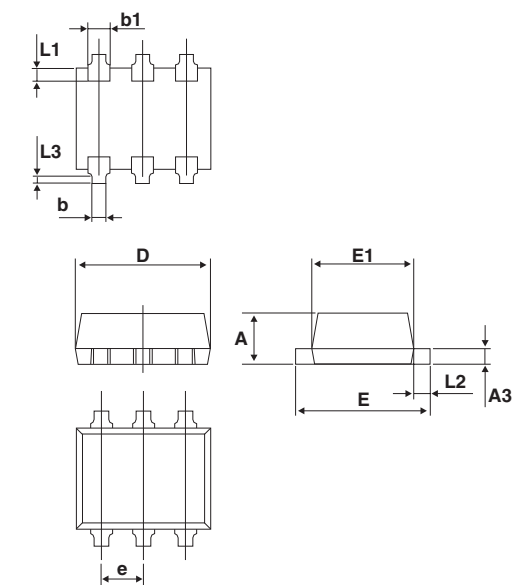
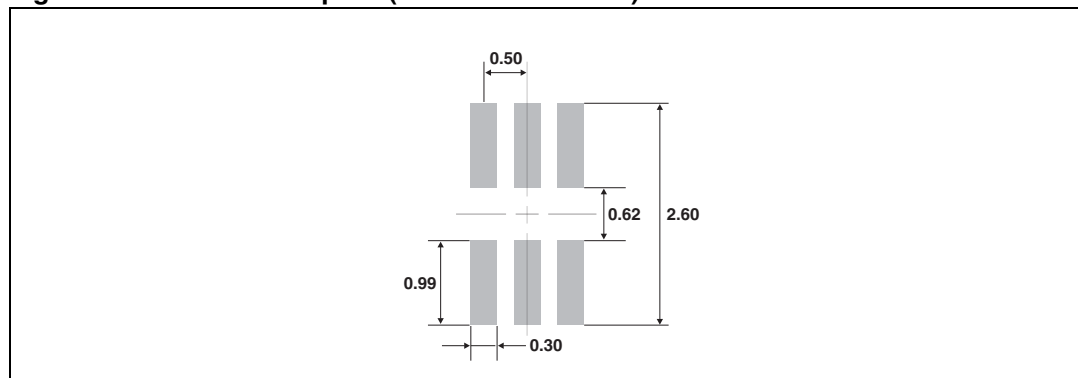

Table 9. SOT-666 dimensions



Ref.	Dimensions					
	Millimeters			Inches		
	Min.	Typ.	Max.	Min.	Typ.	Max.
A	0.45		0.60	0.018		0.024
A3	0.08		0.18	0.003		0.007
b	0.17		0.34	0.007		0.013
b1	0.19	0.27	0.34	0.007	0.011	0.013
D	1.50		1.70	0.059		0.067
E	1.50		1.70	0.059		0.067
E1	1.10		1.30	0.043		0.051
e		0.50			0.020	
L1		0.19			0.007	
L2	0.10		0.30	0.004		0.012
L3		0.10			0.004	

Figure 17. SOT-666 footprint (dimensions in mm)



In order to meet environmental requirements, ST offers these devices in ECOPACK® packages. These packages have a lead-free second level interconnect. The category of second level interconnect is marked on the package and on the inner box label, in compliance with JEDEC Standard JESD97. The maximum ratings related to soldering conditions are also marked on the inner box label. ECOPACK is an ST trademark. ECOPACK specifications are available at: www.st.com.

4 Ordering information

Part Number	Marking	Package	Weight	Base qty	Delivery mode
BAT30FILM	B30	SOT-23 Single	10 mg	3000	Tape and reel
BAT30SFILM	S30	SOT-23 Serial	10 mg	3000	Tape and reel
BAT30CFILM	C30	SOT-23 Common cathode	10 mg	3000	Tape and reel
BAT30AFILM	A30	SOT-23 Common anode	10 mg	3000	Tape and reel
BAT30WFILM	B30	SOT-323 Single	6 mg	3000	Tape and reel
BAT30SWFILM	S30	SOT-323 Serial	6 mg	3000	Tape and reel
BAT30CWFILM	C30	SOT-323 Common cathode	6 mg	3000	Tape and reel
BAT30AWFILM	A30	SOT-323 Common anode	6 mg	3000	Tape and reel
BAT30JFILM	30	SOD-323	5 mg	3000	Tape and reel
BAT30KFILM	30	SOD-523	1.4 mg	3000	Tape and reel
BAT30-07P6FILM	P3	SOT-666 Parallel	2.9 mg	5000	Tape and reel
BAT30-09P6FILM	Q3	SOT-666 Opposite	2.9 mg	5000	Tape and reel

5 Revision history

Date	Revision	Description of Changes
24-Jul-2006	1	First issue

Please Read Carefully:

Information in this document is provided solely in connection with ST products. STMicroelectronics NV and its subsidiaries ("ST") reserve the right to make changes, corrections, modifications or improvements, to this document, and the products and services described herein at any time, without notice.

All ST products are sold pursuant to ST's terms and conditions of sale.

Purchasers are solely responsible for the choice, selection and use of the ST products and services described herein, and ST assumes no liability whatsoever relating to the choice, selection or use of the ST products and services described herein.

No license, express or implied, by estoppel or otherwise, to any intellectual property rights is granted under this document. If any part of this document refers to any third party products or services it shall not be deemed a license grant by ST for the use of such third party products or services, or any intellectual property contained therein or considered as a warranty covering the use in any manner whatsoever of such third party products or services or any intellectual property contained therein.

UNLESS OTHERWISE SET FORTH IN ST'S TERMS AND CONDITIONS OF SALE ST DISCLAIMS ANY EXPRESS OR IMPLIED WARRANTY WITH RESPECT TO THE USE AND/OR SALE OF ST PRODUCTS INCLUDING WITHOUT LIMITATION IMPLIED WARRANTIES OF MERCHANTABILITY, FITNESS FOR A PARTICULAR PURPOSE (AND THEIR EQUIVALENTS UNDER THE LAWS OF ANY JURISDICTION), OR INFRINGEMENT OF ANY PATENT, COPYRIGHT OR OTHER INTELLECTUAL PROPERTY RIGHT.

UNLESS EXPRESSLY APPROVED IN WRITING BY AN AUTHORIZED ST REPRESENTATIVE, ST PRODUCTS ARE NOT RECOMMENDED, AUTHORIZED OR WARRANTED FOR USE IN MILITARY, AIR CRAFT, SPACE, LIFE SAVING, OR LIFE SUSTAINING APPLICATIONS, NOR IN PRODUCTS OR SYSTEMS WHERE FAILURE OR MALFUNCTION MAY RESULT IN PERSONAL INJURY, DEATH, OR SEVERE PROPERTY OR ENVIRONMENTAL DAMAGE. ST PRODUCTS WHICH ARE NOT SPECIFIED AS "AUTOMOTIVE GRADE" MAY ONLY BE USED IN AUTOMOTIVE APPLICATIONS AT USER'S OWN RISK.

Resale of ST products with provisions different from the statements and/or technical features set forth in this document shall immediately void any warranty granted by ST for the ST product or service described herein and shall not create or extend in any manner whatsoever, any liability of ST.

ST and the ST logo are trademarks or registered trademarks of ST in various countries.

Information in this document supersedes and replaces all information previously supplied.

The ST logo is a registered trademark of STMicroelectronics. All other names are the property of their respective owners.

© 2006 STMicroelectronics - All rights reserved

STMicroelectronics group of companies

Australia - Belgium - Brazil - Canada - China - Czech Republic - Finland - France - Germany - Hong Kong - India - Israel - Italy - Japan - Malaysia - Malta - Morocco - Singapore - Spain - Sweden - Switzerland - United Kingdom - United States of America

www.st.com