

## Ultrafast recovery diode

### Main product characteristics

$I_{F(AV)}$	20 A
$V_{RRM}$	200 V
$T_j$ (max)	175° C
$V_F$ (typ)	0.86 V
$t_{rr}$ (typ)	16 ns

### Features and benefits

- Ultrafast switching
- Low reverse current
- Low thermal resistance
- Reduces switching and conduction losses
- High  $T_j$
- Insulating voltage: 2500  $V_{rms}$
- Capacitance: 7 pF

### Description

Single rectifier suited for switch mode power supply and high frequency DC to DC converter. Packaged in D<sup>2</sup>PAK, TO-220AC and insulated TO-220AC, this device is intended for low voltage, high frequency inverters, free wheeling and polarity protection applications

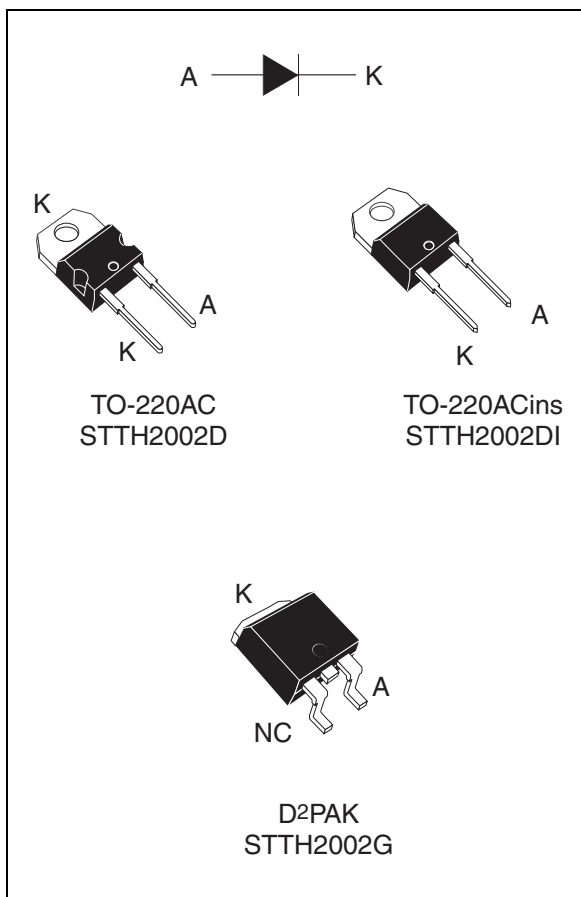

### Order codes

Part Number	Marking
STTH2002D	STTH2002
STTH2002DI	STTH2002
STTH2002G	STTH2002
STTH2002G-TR	STTH2002

# 1 Characteristics

**Table 1. Absolute ratings (limiting values at  $T_j = 25^\circ\text{C}$ , unless otherwise specified)**

Symbol	Parameter		Value	Unit	
$V_{RRM}$	Repetitive peak reverse voltage		200	V	
$I_{F(RMS)}$	RMS forward current		35	A	
$I_{F(AV)}$	Average forward current, $\delta = 0.5$	TO-220AC, D <sup>2</sup> PAK	$T_c = 120^\circ\text{C}$	20	A
		TO-220ACins	$T_c = 60^\circ\text{C}$		
$I_{FSM}$	Surge non repetitive forward current	$t_p = 10\text{ ms}$ Sinusoidal		175	A
$T_{stg}$	Storage temperature range		-65 to + 175	$^\circ\text{C}$	
$T_j$	Maximum operating junction temperature		175	$^\circ\text{C}$	

**Table 2. Thermal parameters**

Symbol	Parameter		Value	Unit
$R_{th(j-c)}$	Junction to case	TO-220AC, D <sup>2</sup> PAK	2.4	$^\circ\text{C/W}$
		TO-220ACins	5	

**Table 3. Static electrical characteristics**

Symbol	Parameter	Test conditions		Min.	Typ	Max.	Unit
$I_R^{(1)}$	Reverse leakage current	$T_j = 25^\circ\text{C}$	$V_R = V_{RRM}$			10	$\mu\text{A}$
		$T_j = 125^\circ\text{C}$			10	100	
$V_F^{(2)}$	Forward voltage drop	$T_j = 25^\circ\text{C}$	$I_F = 20\text{ A}$		1	1.1	V
		$T_j = 150^\circ\text{C}$			0.86	0.95	
		$T_j = 25^\circ\text{C}$	$I_F = 25\text{ A}$			1.15	
		$T_j = 125^\circ\text{C}$			0.94	1.05	
		$T_j = 150^\circ\text{C}$			0.9	1	

1. Pulse test:  $t_p = 5\text{ ms}$ ,  $\delta < 2\%$

2. Pulse test:  $t_p = 380\text{ }\mu\text{s}$ ,  $\delta < 2\%$

To evaluate the conduction losses use the following equation:

$$P = 0.75 \times I_{F(AV)} + 0.01 I_{F(RMS)}^2$$

Table 4. Dynamic characteristics

Symbol	Parameter	Test conditions	Min.	Typ	Max.	Unit
$t_{rr}$	Reverse recovery time	$I_F = 1\text{ A}$ , $di_F/dt = -200\text{ A}/\mu\text{s}$ , $V_R = 30\text{ V}$ , $T_j = 25\text{ }^\circ\text{C}$		16	20	ns
		$I_F = 1\text{ A}$ , $di_F/dt = -50\text{ A}/\mu\text{s}$ , $V_R = 30\text{ V}$ , $T_j = 25\text{ }^\circ\text{C}$		33	40	
$I_{RM}$	Reverse recovery current	$I_F = 20\text{ A}$ , $di_F/dt = 100\text{ A}/\mu\text{s}$ , $V_R = 160\text{ V}$ , $T_j = 125\text{ }^\circ\text{C}$		8	10	A
$t_{fr}$	Forward recovery time	$I_F = 20\text{ A}$ , $di_F/dt = 100\text{ A}/\mu\text{s}$ , $V_{FR} = 1.1 \times V_{Fmax}$ , $T_j = 25\text{ }^\circ\text{C}$		230		ns
$V_{FP}$	Forward recovery voltage	$I_F = 20\text{ A}$ , $di_F/dt = 100\text{ A}/\mu\text{s}$ , $V_{FR} = 1.1 \times V_{Fmax}$ , $T_j = 25\text{ }^\circ\text{C}$		2		V

Figure 1. Peak current versus duty cycle

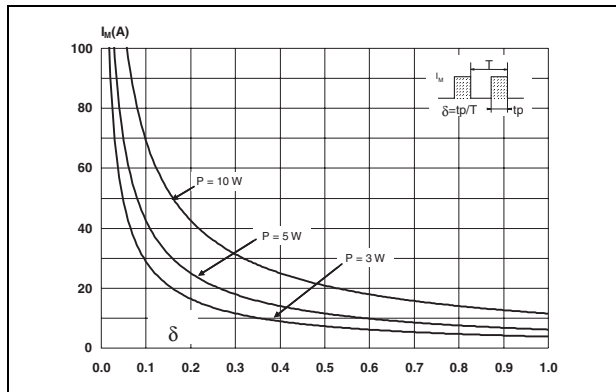

Figure 2. Forward voltage drop versus forward current (typical values)

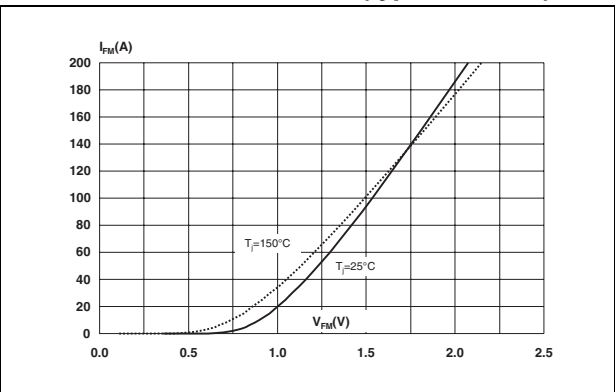

Figure 3. Forward voltage drop versus forward current (maximum values)

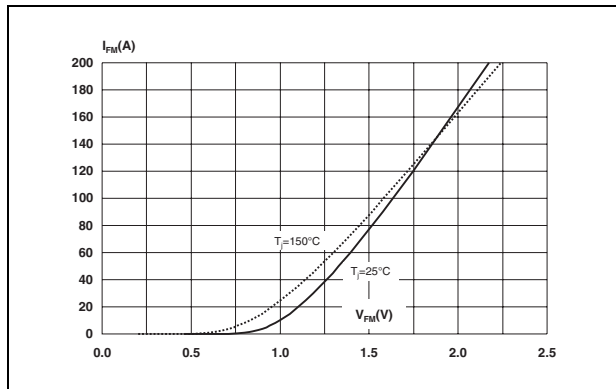
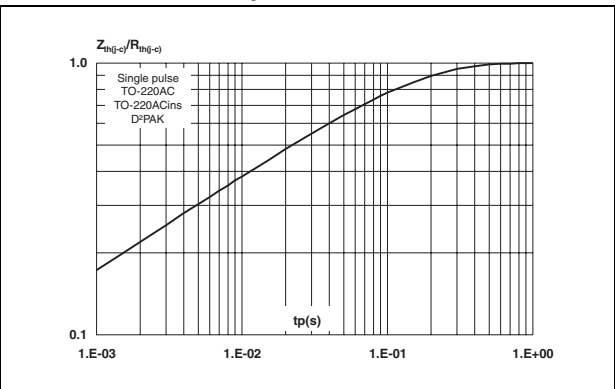
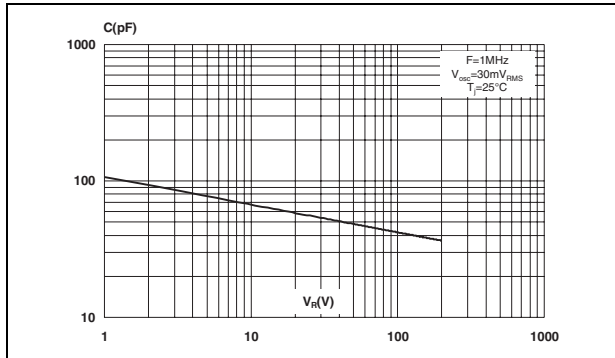

Figure 4. Relative variation of thermal impedance, junction to case, versus pulse duration



**Figure 5. Junction capacitance versus reverse applied voltage (typical values)**



**Figure 6. Reverse recovery charges versus  $di_F/dt$  (typical values)**

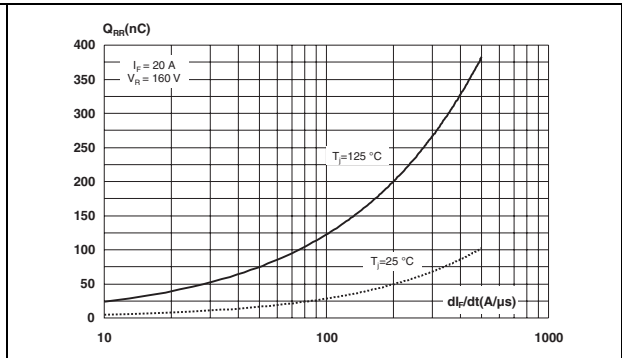

**Figure 7. Reverse recovery time versus  $di_F/dt$  (typical values)**

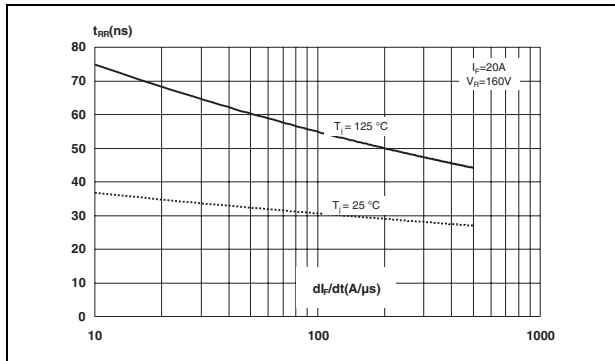

**Figure 8. Peak reverse recovery current versus  $di_F/dt$  (typical values)**

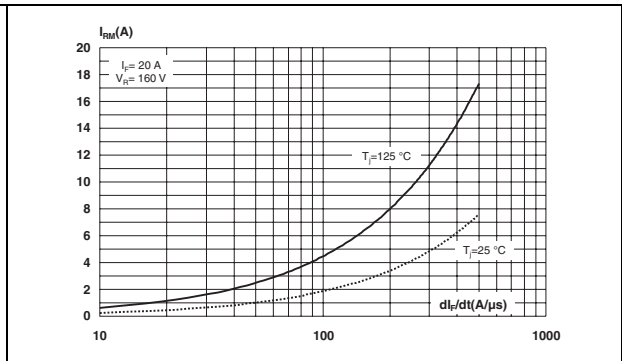

**Figure 9. Dynamic parameters versus junction temperature**

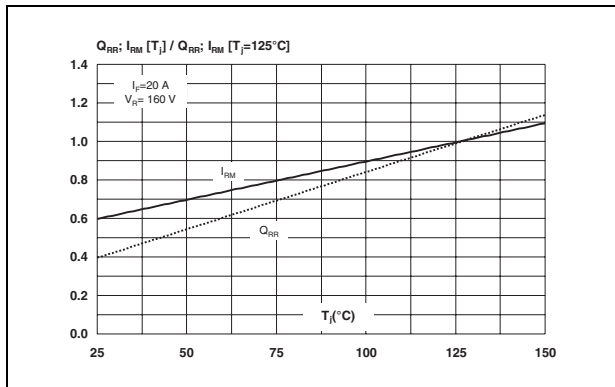

**Figure 10. Thermal resistance, junction to ambient, versus copper surface under tab (Epoxy printed circuit board FR4,  $e_{Cu} = 35 \mu m$ ) for D<sup>2</sup>PAK**

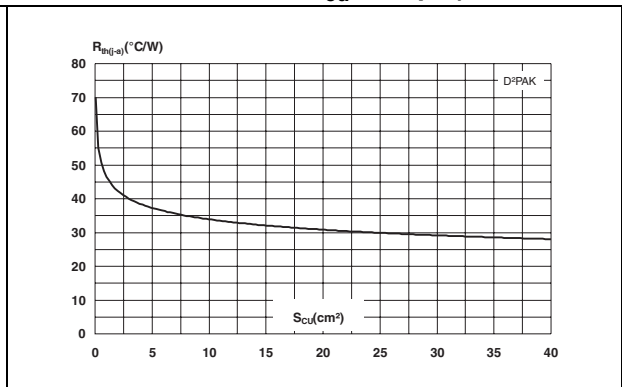

## 2 Ordering information scheme

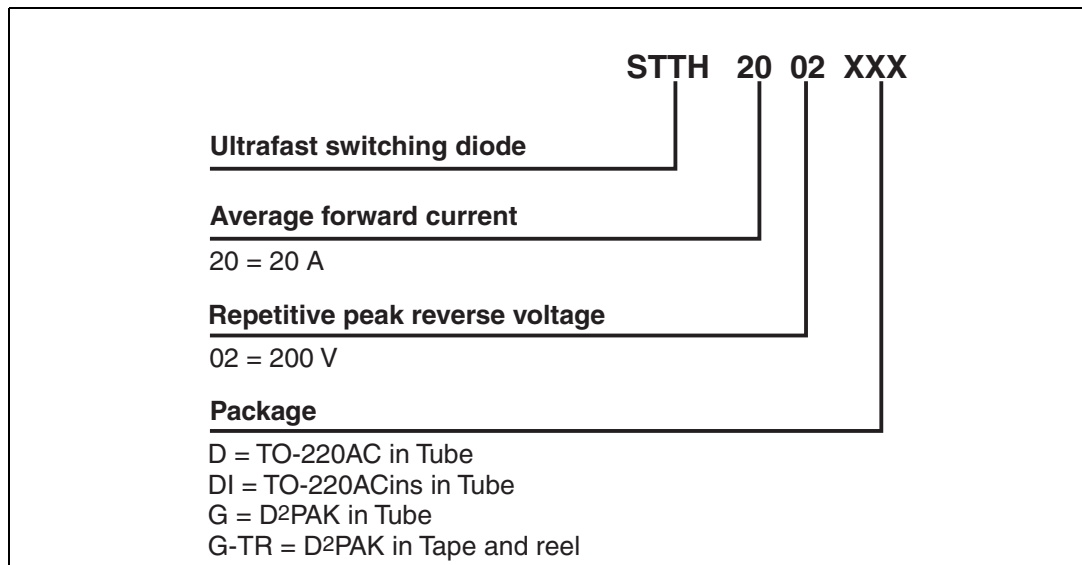

### 3 Package information

Epoxy meets UL94, V0  
 Cooling method: by conduction (C)  
 Recommended torque value: 0.8 Nm  
 Maximum torque value: 1.0 Nm

**Table 5. T0-220AC dimensions**

REF.	DIMENSIONS			
	Millimeters		Inches	
	Min.	Max.	Min.	Max.
A	4.40	4.60	0.173	0.181
C	1.23	1.32	0.048	0.051
D	2.40	2.72	0.094	0.107
E	0.49	0.70	0.019	0.027
F	0.61	0.88	0.024	0.034
F1	1.14	1.70	0.044	0.066
G	4.95	5.15	0.194	0.202
H2	10.00	10.40	0.393	0.409
L2	16.40 typ.		0.645 typ.	
L4	13.00	14.00	0.511	0.551
L5	2.65	2.95	0.104	0.116
L6	15.25	15.75	0.600	0.620
L7	6.20	6.60	0.244	0.259
L9	3.50	3.93	0.137	0.154
M	2.6 typ.		0.102 typ.	
Diam. I	3.75	3.85	0.147	0.151

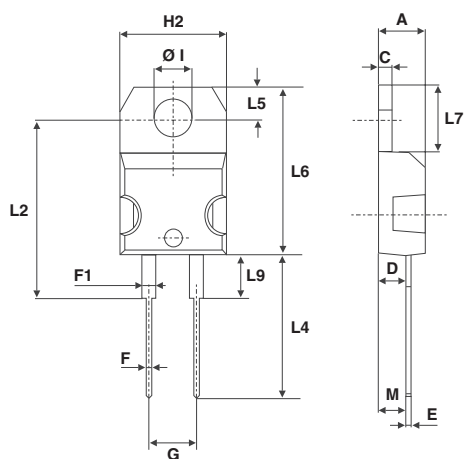

Table 6. T0-220ACins dimensions

REF	DIMENSIONS					
	Millimeters			Inches		
	Min.	Typ.	Max.	Min.	Typ.	Max.
A	15.20		15.90	0.598		0.625
a1		3.75			0.147	
a2	13.00		14.00	0.511		0.551
B	10.00		10.40	0.393		0.409
b1	0.61		0.88	0.024		0.034
b2	1.23		1.32	0.048		0.051
C	4.40		4.60	0.173		0.181
c1	0.49		0.70	0.019		0.027
c2	2.40		2.72	0.094		0.107
e	2.40		2.70	0.094		0.106
F	6.20		6.60	0.244		0.259
ØI	3.75		3.85	0.147		0.151
l4	15.80	16.40	16.80	0.622	0.646	0.661
L	2.65		2.95	0.104		0.116
l2	1.14		1.70	0.044		0.066
l3	1.14		1.70	0.044		0.066
M		2.60			0.102	

Table 7. D<sup>2</sup>PAK dimensions

REF.	DIMENSIONS			
	Millimeters		Inches	
	Min.	Max	Min.	Max.
A	4.40	4.60	0.173	0.181
A1	2.49	2.69	0.098	0.106
A2	0.03	0.23	0.001	0.009
B	0.70	0.93	0.027	0.037
B2	1.14	1.70	0.045	0.067
C	0.45	0.60	0.017	0.024
C2	1.23	1.36	0.048	0.054
D	8.95	9.35	0.352	0.368
E	10.00	10.40	0.393	0.409
G	4.88	5.28	0.192	0.208
L	15.00	15.85	0.590	0.624
L2	1.27	1.40	0.050	0.055
L3	1.40	1.75	0.055	0.069
M	2.40	3.20	0.094	0.126
R	0.40 typ.		0.016 typ.	
V2	0°	8°	0°	8°

Figure 11. D<sup>2</sup>PAK footprint (dimensions in mm)

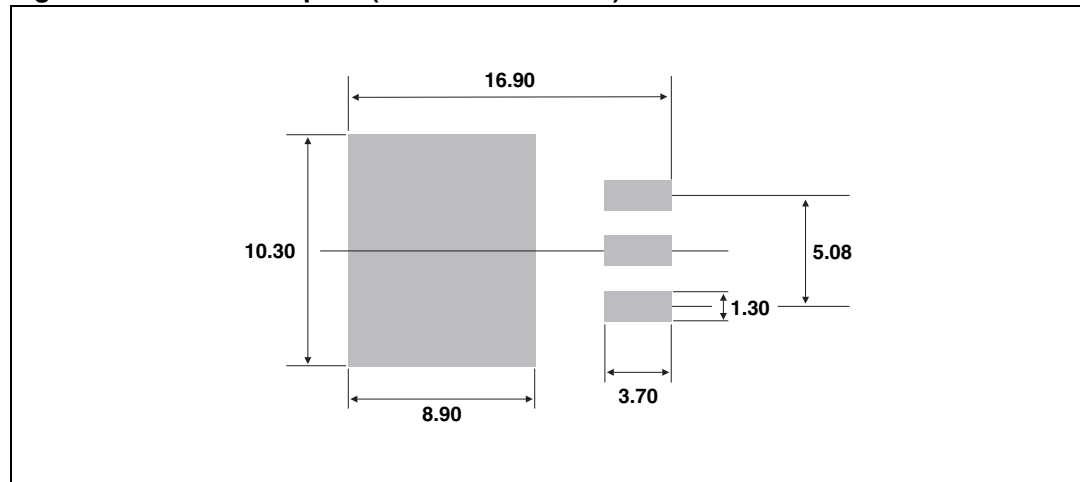

In order to meet environmental requirements, ST offers these devices in ECOPACK® packages. These packages have a lead-free second level interconnect. The category of second level interconnect is marked on the package and on the inner box label, in compliance with JEDEC Standard JESD97. The maximum ratings related to soldering conditions are also marked on the inner box label. ECOPACK is an ST trademark. ECOPACK specifications are available at: [www.st.com](http://www.st.com).



## 4 Ordering information

Part Number	Marking	Package	Weight	Base qty	Delivery mode
STTH2002D	STTH2002	TO-220AC	1.90 g	50	Tube
STTH2002DI	STTH2002	TO-220ACins	2.30 g	50	Tube
STTH2002G	STTH2002	D <sup>2</sup> PAK	1.48 g	50	Tube
STTH2002G-TR	STTH2002	D <sup>2</sup> PAK	1.48 g	1000	Tape and reel

## 5 Revision history

Date	Revision	Description of Changes
03-May-2006	1	First issue

Please Read Carefully:

Information in this document is provided solely in connection with ST products. STMicroelectronics NV and its subsidiaries ("ST") reserve the right to make changes, corrections, modifications or improvements, to this document, and the products and services described herein at any time, without notice.

All ST products are sold pursuant to ST's terms and conditions of sale.

Purchasers are solely responsible for the choice, selection and use of the ST products and services described herein, and ST assumes no liability whatsoever relating to the choice, selection or use of the ST products and services described herein.

No license, express or implied, by estoppel or otherwise, to any intellectual property rights is granted under this document. If any part of this document refers to any third party products or services it shall not be deemed a license grant by ST for the use of such third party products or services, or any intellectual property contained therein or considered as a warranty covering the use in any manner whatsoever of such third party products or services or any intellectual property contained therein.

**UNLESS OTHERWISE SET FORTH IN ST'S TERMS AND CONDITIONS OF SALE ST DISCLAIMS ANY EXPRESS OR IMPLIED WARRANTY WITH RESPECT TO THE USE AND/OR SALE OF ST PRODUCTS INCLUDING WITHOUT LIMITATION IMPLIED WARRANTIES OF MERCHANTABILITY, FITNESS FOR A PARTICULAR PURPOSE (AND THEIR EQUIVALENTS UNDER THE LAWS OF ANY JURISDICTION), OR INFRINGEMENT OF ANY PATENT, COPYRIGHT OR OTHER INTELLECTUAL PROPERTY RIGHT.**

**UNLESS EXPRESSLY APPROVED IN WRITING BY AN AUTHORIZED REPRESENTATIVE OF ST, ST PRODUCTS ARE NOT DESIGNED, AUTHORIZED OR WARRANTED FOR USE IN MILITARY, AIR CRAFT, SPACE, LIFE SAVING, OR LIFE SUSTAINING APPLICATIONS, NOR IN PRODUCTS OR SYSTEMS, WHERE FAILURE OR MALFUNCTION MAY RESULT IN PERSONAL INJURY, DEATH, OR SEVERE PROPERTY OR ENVIRONMENTAL DAMAGE.**

Resale of ST products with provisions different from the statements and/or technical features set forth in this document shall immediately void any warranty granted by ST for the ST product or service described herein and shall not create or extend in any manner whatsoever, any liability of ST.

ST and the ST logo are trademarks or registered trademarks of ST in various countries.

Information in this document supersedes and replaces all information previously supplied.

The ST logo is a registered trademark of STMicroelectronics. All other names are the property of their respective owners.

© 2006 STMicroelectronics - All rights reserved

STMicroelectronics group of companies

Australia - Belgium - Brazil - Canada - China - Czech Republic - Finland - France - Germany - Hong Kong - India - Israel - Italy - Japan - Malaysia - Malta - Morocco - Singapore - Spain - Sweden - Switzerland - United Kingdom - United States of America

[www.st.com](http://www.st.com)