

Output Rail-to-Rail Micropower Operational Amplifiers

- Rail-to-rail output voltage swing
- Micropower consumption (20µA)
- Single supply operation (2.7V to 10V)
- Low offset (2mV max for TS93xB)
- CMOS inputs
- Ultra low input bias current (1pA)
- ESD protection (2kV)
- Latch-up immunity (class A)
- Available in SOT23-5 micropackage

Description

The TS93x (single, dual & quad) series are operational amplifiers able to operate with voltage as low as 2.7V and to reach 2.9Vpp of output swing with $R_L = 100k\Omega$ when supplied @ 3V.

Offering a typical consumption of only 20µA, they are particularly well-suited for battery-powered applications.

Fitting the TS93x onto your board design is very easy because of its space-saving 5-pin SOT23-5 package with outer dimensions of 2.8mm x 2.9mm.

Applications

- Battery-powered systems
- Portable communication systems
- Alarm, smoke detectors
- Instrumentation & sensing
- PH Meter
- Digital scales

Pin Connections (top view)

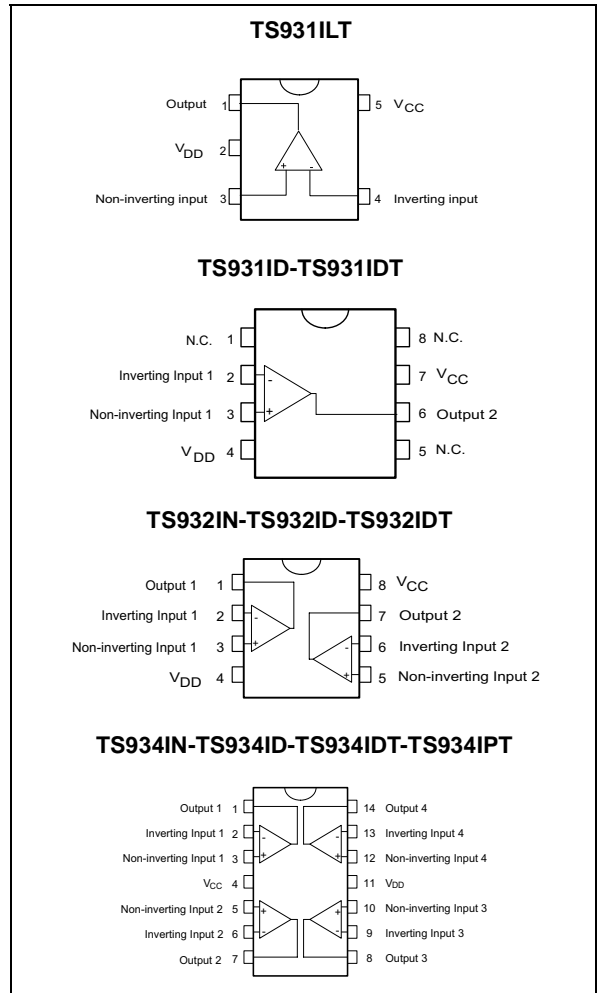

Order Codes

Part Number	Temperature Range	Package	Packaging	Marking
TS931ID/IDT/AID/AIDT/BID/BIDT	-40°C, +85°C	SO	Tube or Tape & Reel	
TS931ILT/AILT/BILT		SOT23-5L	Tape & Reel	K205 K206 K207
TS932IN/AIN/BIN		DIP	Tube	
TS932ID/IDT/AID/AIDT/BID/BIDT		SO	Tube or Tape & Reel	
TS934IN/AIN/BIN		DIP	Tube	
TS934ID/IDT/AID/AIDT/BIDT/BIDT		SO	Tube or Tape & Reel	
TS934IPT/AIPT/BIPT		TSSOP (Thin Shrink Outline Package)	Tape & Reel	

1 Absolute Maximum Ratings

Table 1: Key parameters and their absolute maximum ratings

Symbol	Parameter	Value	Unit
VCC	Supply voltage ¹	12	V
V _{id}	Differential Input Voltage ²	±12	V
V _{in}	Input Voltage Range ³	V _{dd} -0.3 to V _{CC} +0.3	V
T _{oper}	Operating Free Air Temperature Range	-40 to + 85	°C
T _{std}	Storage Temperature Range	-65 to +150	°C
T _j	Maximum Junction Temperature	150	°C
R _{thja}	Thermal Resistance Junction to Ambient ⁴		°C/W
	SOT23-5	250	
	DIP8	85	
	DIP14	66	
	SO8	125	
	SO14	103	
	TSSOP8	120	
	TSSOP14	100	
ESD	HBM: Human Body Model ⁵	2	kV
	MM: Machine Model ⁶	200	V
	CDM: Charged Device Model	2	kV
	Latch-up Immunity	200	mA
	Soldering Temperature (10sec), leaded version	250	°C

- 1) All voltages values, except differential voltage are with respect to network terminal.
- 2) Differential voltages are non-inverting input terminal with respect to the inverting input terminal.
- 3) The magnitude of input and output voltages must never exceed V_{CC} +0.3V.
- 4) Short-circuits can cause excessive heating and destructive dissipation.
- 5) Human body model, 100pF discharged through a 1.5kΩ resistor into pin of device.
- 6) Machine model ESD, a 200pF cap is charged to the specified voltage, then discharged directly into the IC with no external series resistor (internal resistor < 5Ω), into pin to pin of device.

Table 2: Operating Conditions

Symbol	Parameter	Value	Unit
VCC	Supply Voltage	2.7 to 10	V
V _{icm}	Common Mode Input Voltage Range	V _{dd} - 0.2 to V _{CC} - 1.5	V
T _{oper}	Operating Free Air Temperature Range	-40 to + 85	°C

2 Electrical Characteristics

Tables 3 and 4 give the electrical characteristics at each V_{CC} value.

Table 3: $V_{CC} = +3V$, $V_{dd} = 0V$, $T_{amb} = 25^{\circ}C$ (unless otherwise specified)

Symbol	Parameter	Min.	Typ.	Max.	Unit
V_{io}	Input Offset Voltage TS931/2/4 TS931/2/4A TS931/2/4B			10 5 2	mV
ΔV_{io}	Input Offset Voltage Drift		3		$\mu V/^{\circ}C$
I_{io}	Input Offset Current ¹		1	100	μA
I_{ib}	Input Bias Current ¹⁾		1	150	μA
CMR	Common Mode Rejection Ratio $0 \leq V_{icm} \leq V_{CC} - 1.7$		85		dB
SVR	Supply Voltage Rejection Ratio ²		85		dB
A_{vd}	Large Signal Voltage Gain $V_O = 2V_{pp}$ $R_L = 1M\Omega$ $R_L = 100k\Omega$		120 106		dB
V_{OH}	High Level Output Voltage $V_{ID} = 100mV$ $R_L = 100k\Omega$	2.95			V
V_{OL}	Low Level Output Voltage $V_{ID} = -100mV$ $R_L = 100k\Omega$			50	mV
I_o	Output Source Current $V_{ID} = 100mV$, $V_O = V_{DD}$ Output Sink Current $V_{ID} = -100mV$, $V_O = V_{CC}$		1.5 1.5		mA
I_{CC}	Supply Current (per amplifier) $A_{VCL} = 1$, no load		20	31	μA
GBP	Gain Bandwidth Product $R_L = 100k\Omega$, $C_L = 50pF$		100		kHz
SR	Slew Rate $R_L = 100k\Omega$, $C_L = 50pF$		50		V/ms
ϕ_m	Phase Margin $C_L = 50pF$		65		Degrees
en	Input Voltage Noise		75		nV/ \sqrt{Hz}

1) Maximum values including unavoidable inaccuracies of the industrial test.

2) V_{CC} has a 0.2V variation.

Table 4: $V_{CC} = +5V$, $V_{dd} = 0V$, $T_{amb} = 25^{\circ}C$ (unless otherwise specified)

Symbol	Parameter	Min.	Typ.	Max.	Unit
V_{io}	Input Offset Voltage TS931/2/4 TS931/2/4A TS931/2/4B			10 5 2	mV
ΔV_{io}	Input Offset Voltage Drift		3		$\mu V/^{\circ}C$
I_{io}	Input Offset Current ¹		1	100	pA
I_{ib}	Input Bias Current ¹⁾		1	150	pA
CMR	Common Mode Rejection Ratio $0 \leq V_{icm} \leq V_{CC} - 1.7$		85		dB
SVR	Supply Voltage Rejection Ratio ²		85		dB
A_{vd}	Large Signal Voltage Gain $V_O = 4V_{pp}$ $R_L = 1M\Omega$ $R_L = 100k\Omega$		120 112		dB
V_{OH}	High Level Output Voltage $V_{ID} = 100mV$ $R_L = 100k\Omega$	4.95			V
V_{OL}	Low Level Output Voltage $V_{ID} = -100mV$ $R_L = 100k\Omega$			50	mV
I_o	Output Source Current $V_{ID} = 100mV$, $V_O = V_{DD}$ Output Sink Current $V_{ID} = -100mV$, $V_O = V_{CC}$		5 5		mA
I_{CC}	Supply Current (per amplifier) $A_{VCL} = 1$, no load		20	33	μA
GBP	Gain Bandwidth Product $R_L = 100K\Omega$, $C_L = 50pF$		100		kHz
SR	Slew Rate $R_L = 100K\Omega$, $C_L = 50pF$		50		V/ms
ϕ_m	Phase Margin $C_L = 50pF$		65		Degrees
en	Input Voltage Noise		76		nV/ \sqrt{Hz}

1) Maximum values including unavoidable inaccuracies of the industrial test.

2) V_{CC} has a 0.2V variation.

Figure 1:

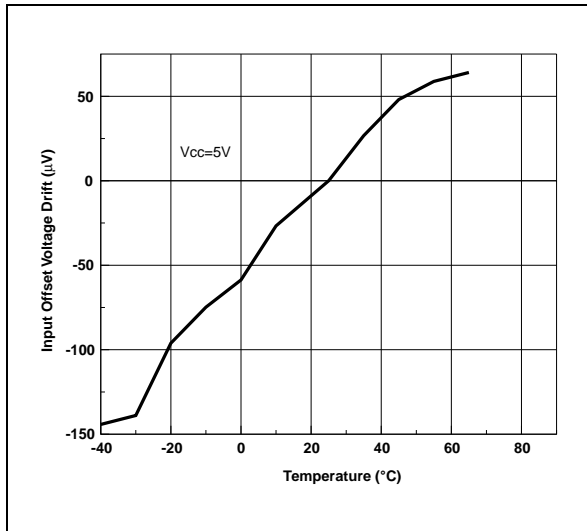

Figure 4:

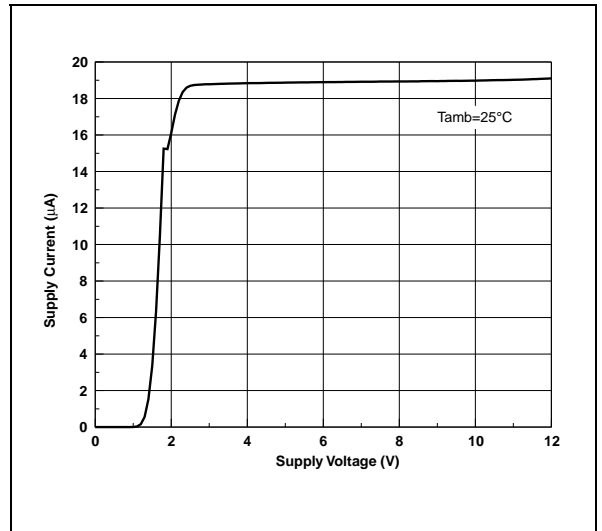

Figure 2:

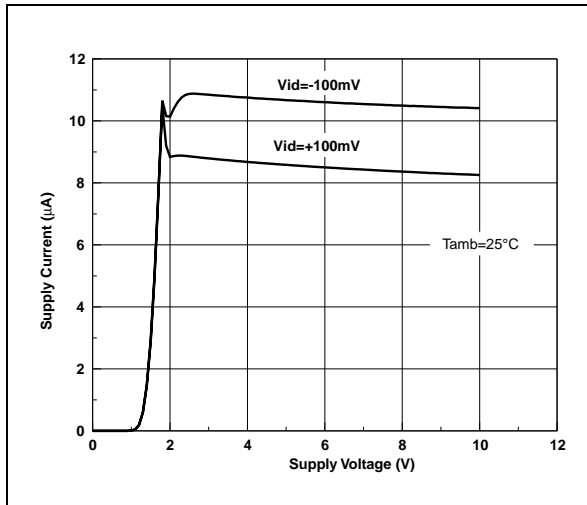

Figure 5:

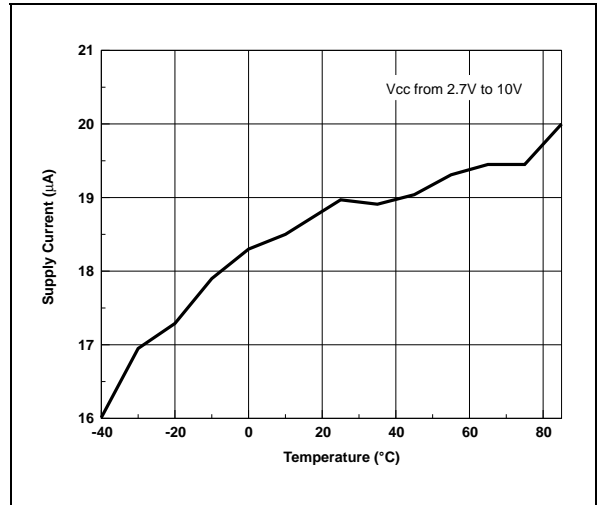

Figure 3:

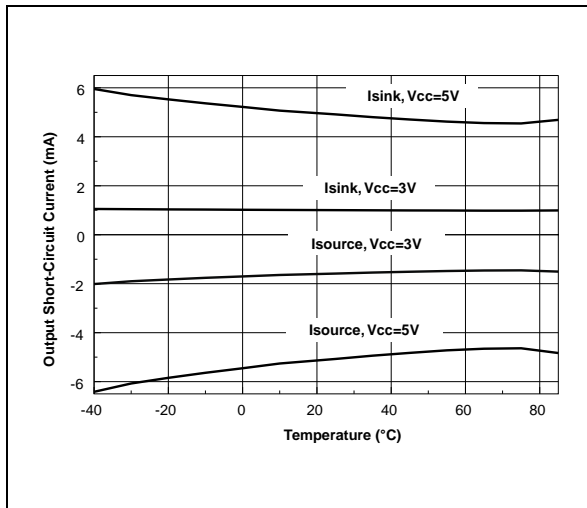

Figure 6:

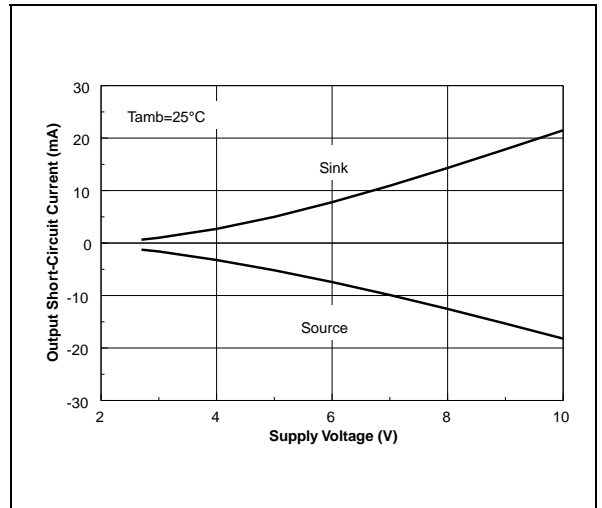

Figure 7:

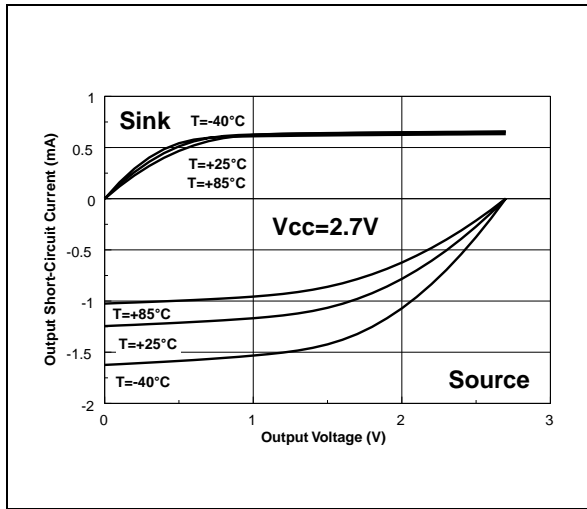

Figure 10:

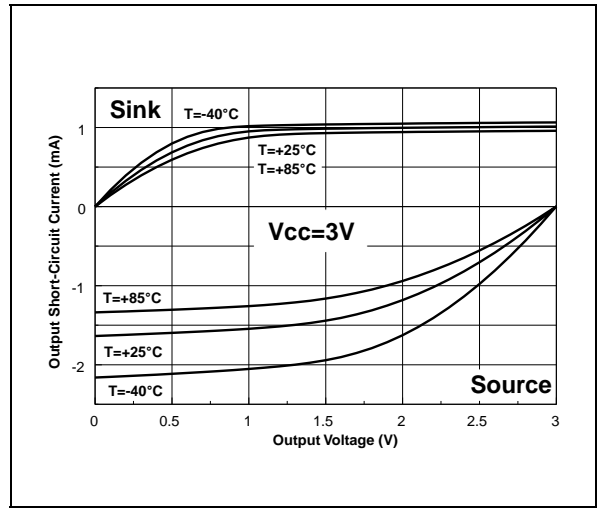

Figure 8:

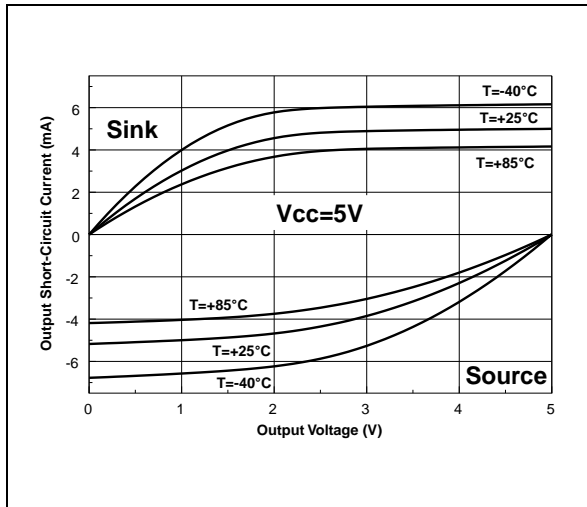

Figure 11:

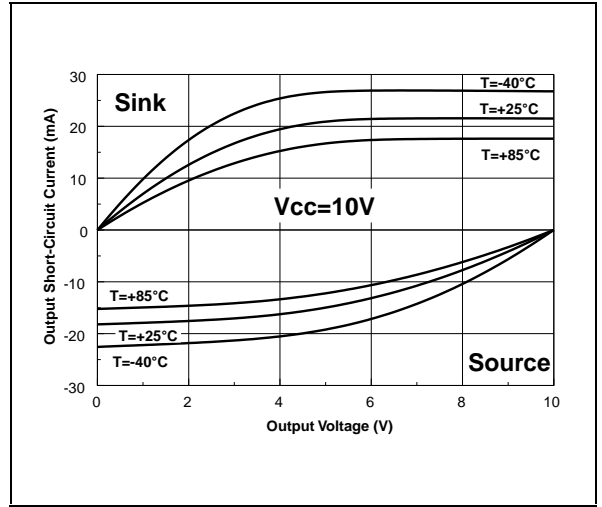

Figure 9:

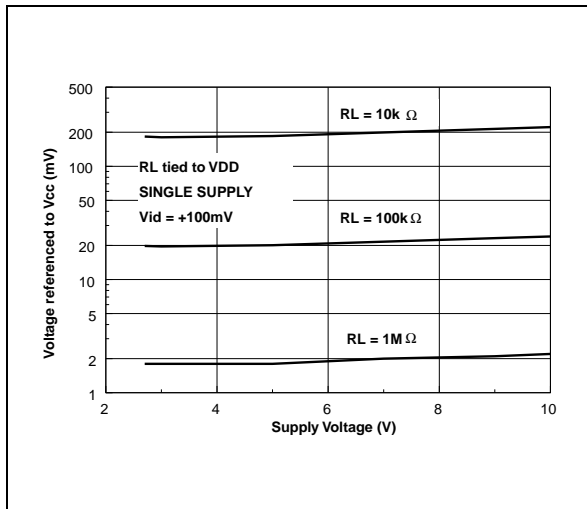

Figure 12:

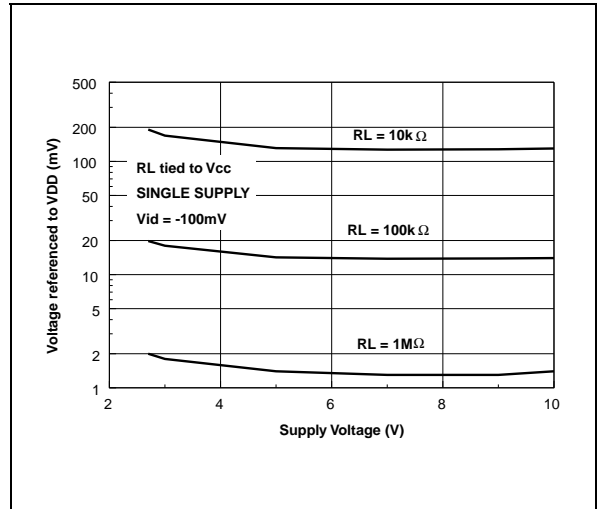

Figure 13:

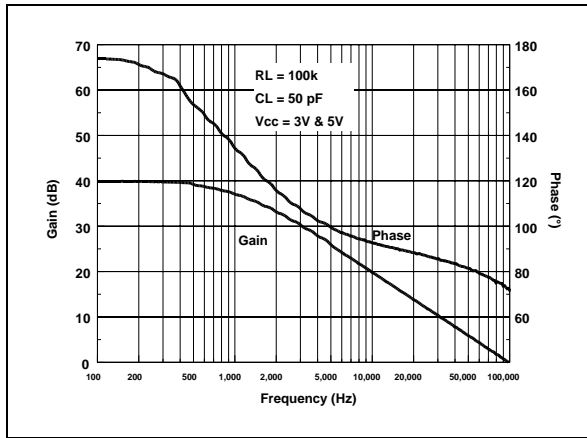

Figure 16:

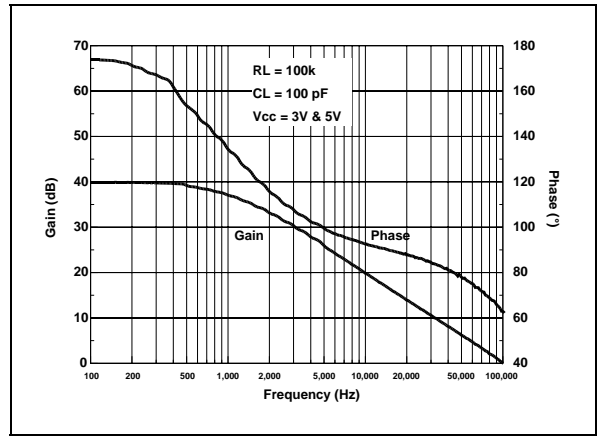

Figure 14:

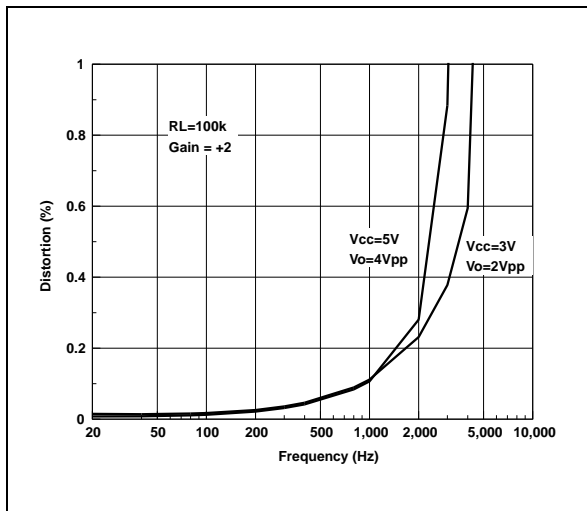

Figure 17:

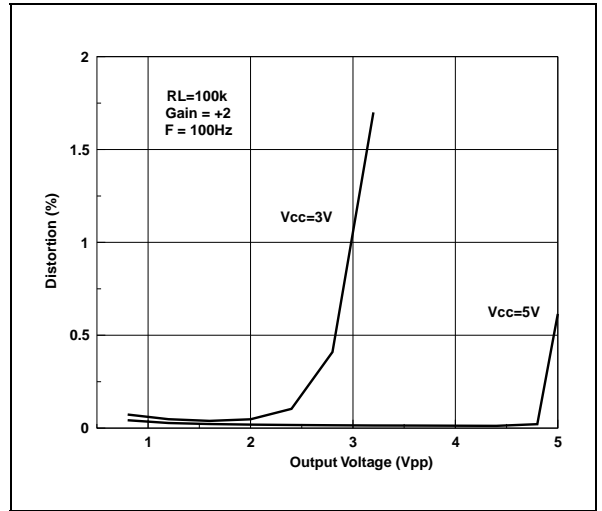

Figure 15:

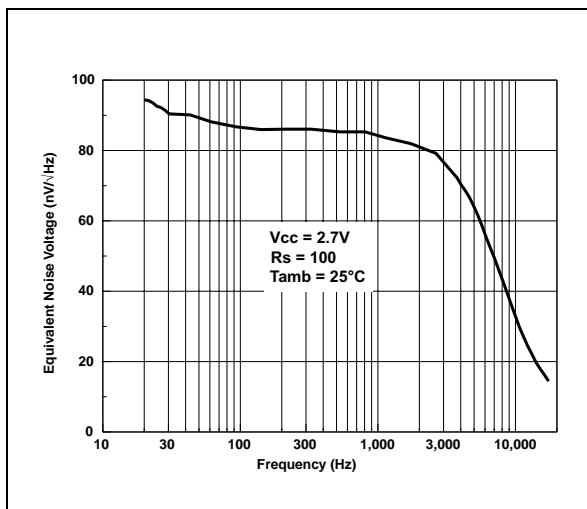

Figure 18:

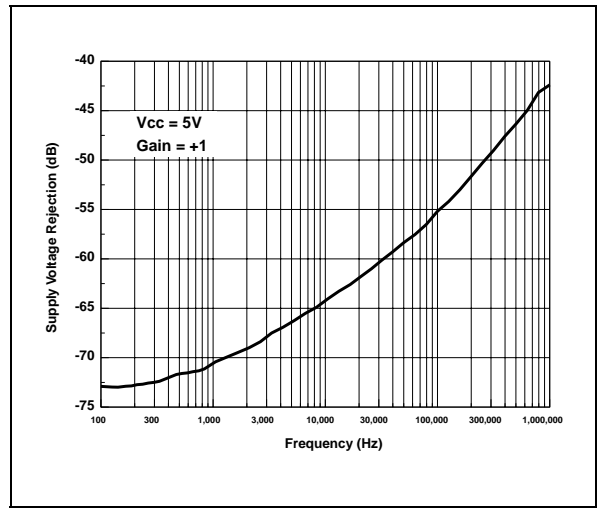

Figure 19:

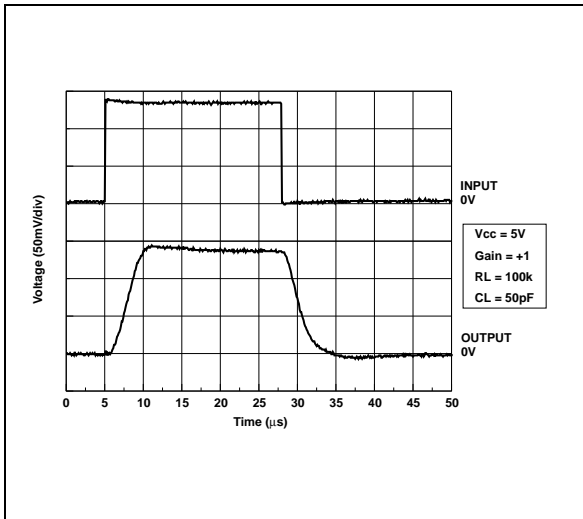
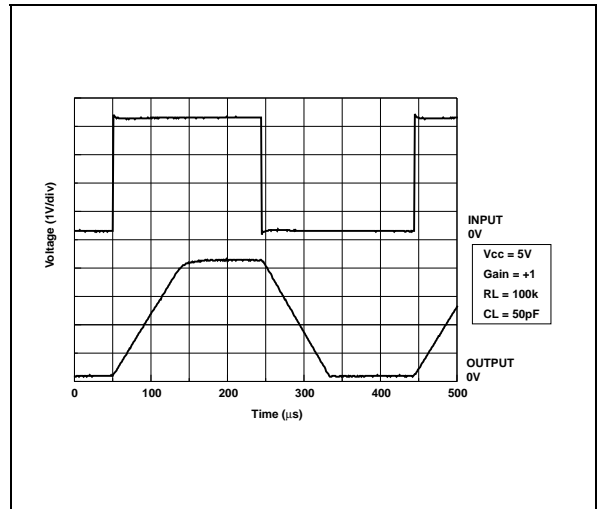

Figure 20:



3 Package Mechanical Data

3.1 DIP8 package

Plastic DIP-8 MECHANICAL DATA

DIM.	mm.			inch		
	MIN.	TYP	MAX.	MIN.	TYP.	MAX.
A		3.3			0.130	
a1	0.7			0.028		
B	1.39		1.65	0.055		0.065
B1	0.91		1.04	0.036		0.041
b		0.5			0.020	
b1	0.38		0.5	0.015		0.020
D			9.8			0.386
E		8.8			0.346	
e		2.54			0.100	
e3		7.62			0.300	
e4		7.62			0.300	
F			7.1			0.280
I			4.8			0.189
L		3.3			0.130	
Z	0.44		1.6	0.017		0.063

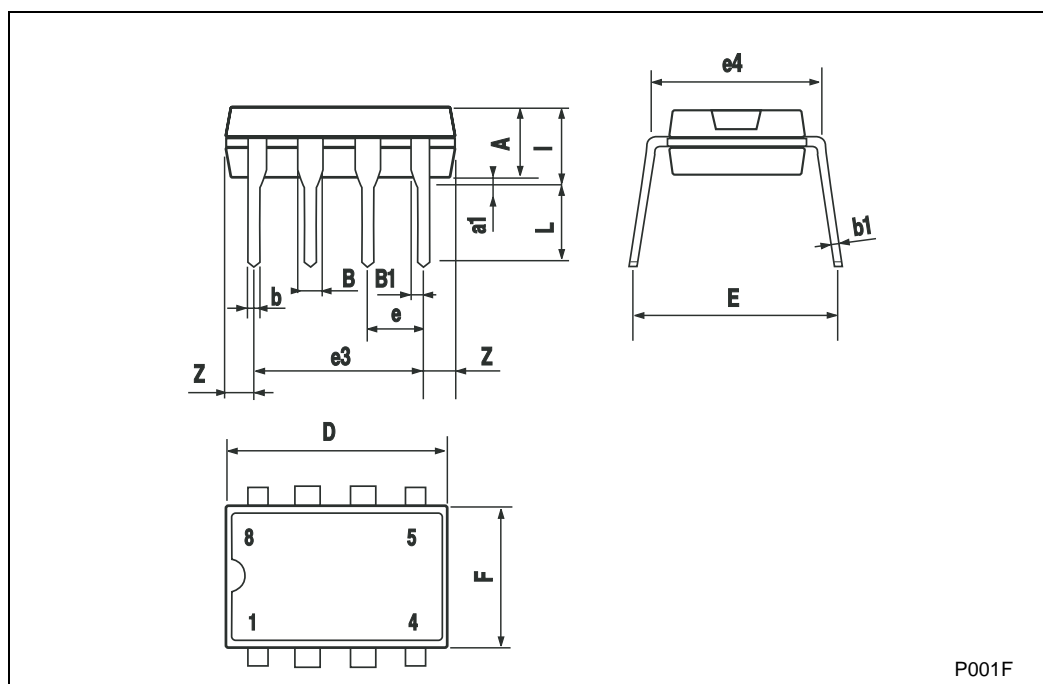

3.2 SO8 package

SO-8 MECHANICAL DATA

DIM.	mm.			inch		
	MIN.	TYP.	MAX.	MIN.	TYP.	MAX.
A	1.35		1.75	0.053		0.069
A1	0.10		0.25	0.04		0.010
A2	1.10		1.65	0.043		0.065
B	0.33		0.51	0.013		0.020
C	0.19		0.25	0.007		0.010
D	4.80		5.00	0.189		0.197
E	3.80		4.00	0.150		0.157
e		1.27			0.050	
H	5.80		6.20	0.228		0.244
h	0.25		0.50	0.010		0.020
L	0.40		1.27	0.016		0.050
k	8° (max.)					
ddd			0.1			0.04

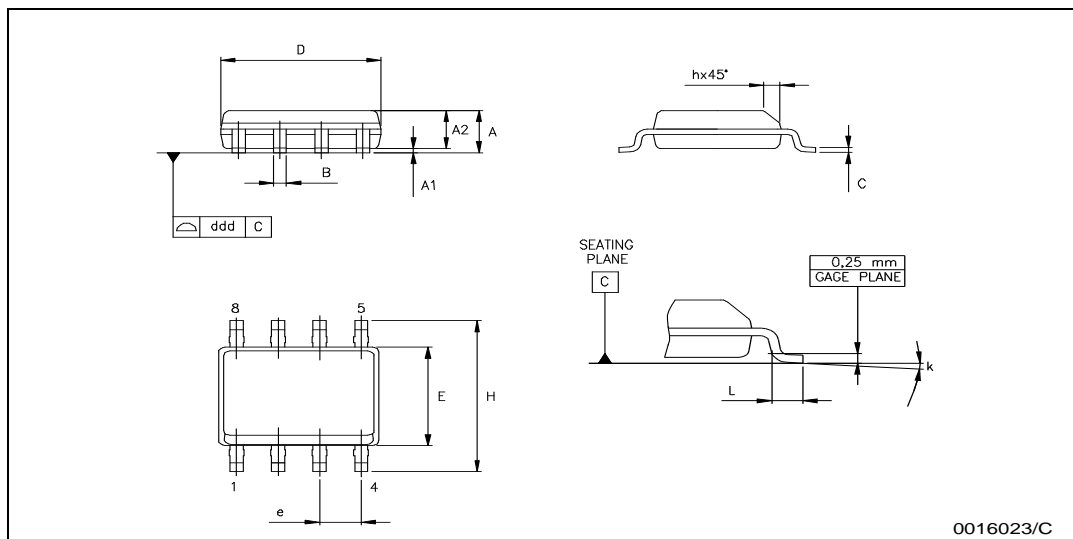

3.3 DIP14 package

Plastic DIP-14 MECHANICAL DATA

DIM.	mm.			inch		
	MIN.	TYP	MAX.	MIN.	TYP.	MAX.
a1	0.51			0.020		
B	1.39		1.65	0.055		0.065
b		0.5			0.020	
b1		0.25			0.010	
D			20			0.787
E		8.5			0.335	
e		2.54			0.100	
e3		15.24			0.600	
F			7.1			0.280
I			5.1			0.201
L		3.3			0.130	
Z	1.27		2.54	0.050		0.100

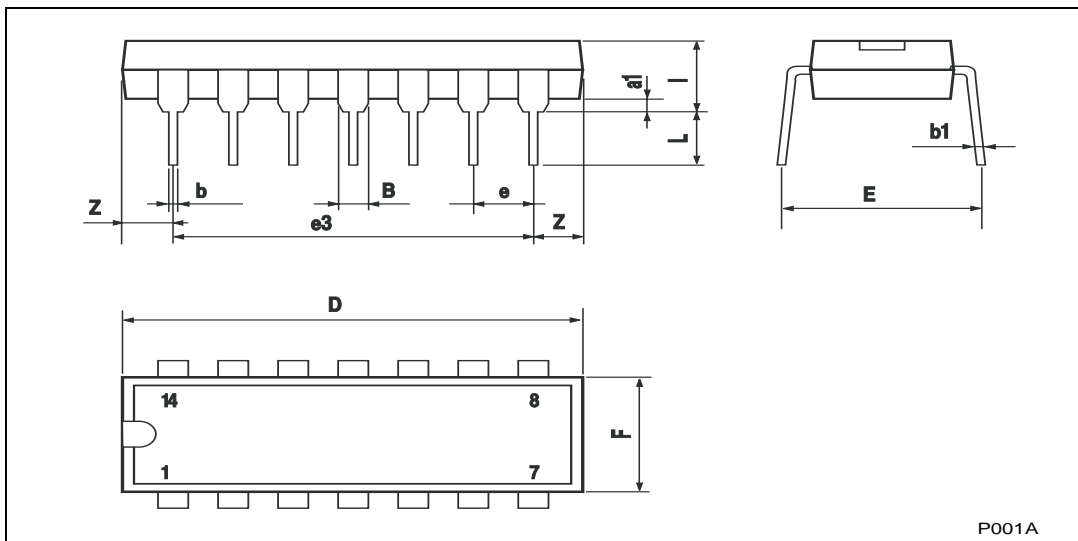

3.4 SO14 package

SO-14 MECHANICAL DATA

DIM.	mm.			inch		
	MIN.	TYP	MAX.	MIN.	TYP.	MAX.
A			1.75			0.068
a1	0.1		0.2	0.003		0.007
a2			1.65			0.064
b	0.35		0.46	0.013		0.018
b1	0.19		0.25	0.007		0.010
C		0.5			0.019	
c1	45° (typ.)					
D	8.55		8.75	0.336		0.344
E	5.8		6.2	0.228		0.244
e		1.27			0.050	
e3		7.62			0.300	
F	3.8		4.0	0.149		0.157
G	4.6		5.3	0.181		0.208
L	0.5		1.27	0.019		0.050
M			0.68			0.026
S	8° (max.)					

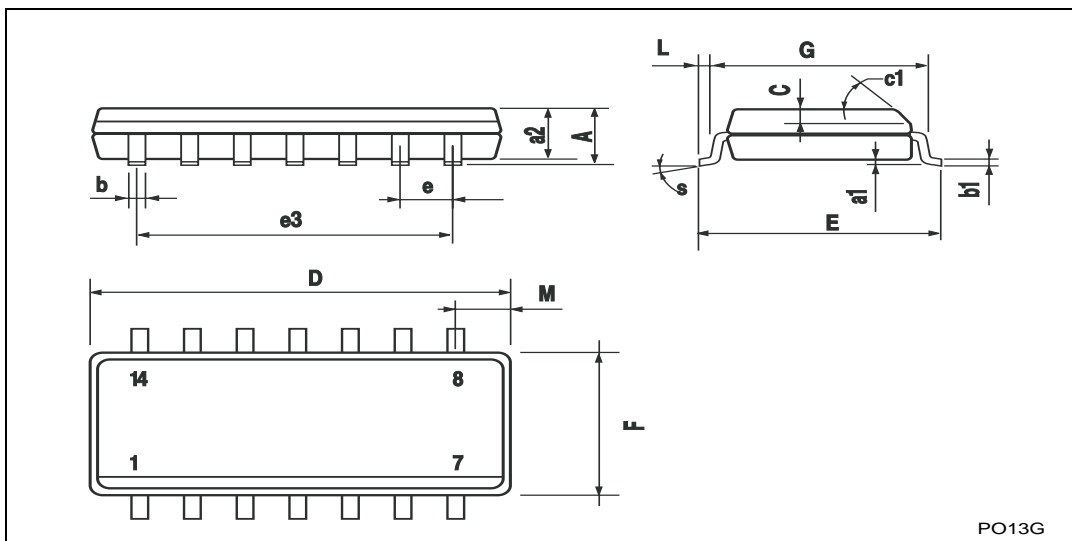

3.5 TSSOP14 package

TSSOP14 MECHANICAL DATA

DIM.	mm.			inch		
	MIN.	TYP	MAX.	MIN.	TYP.	MAX.
A			1.2			0.047
A1	0.05		0.15	0.002	0.004	0.006
A2	0.8	1	1.05	0.031	0.039	0.041
b	0.19		0.30	0.007		0.012
c	0.09		0.20	0.004		0.0089
D	4.9	5	5.1	0.193	0.197	0.201
E	6.2	6.4	6.6	0.244	0.252	0.260
E1	4.3	4.4	4.48	0.169	0.173	0.176
e		0.65 BSC			0.0256 BSC	
K	0°		8°	0°		8°
L	0.45	0.60	0.75	0.018	0.024	0.030

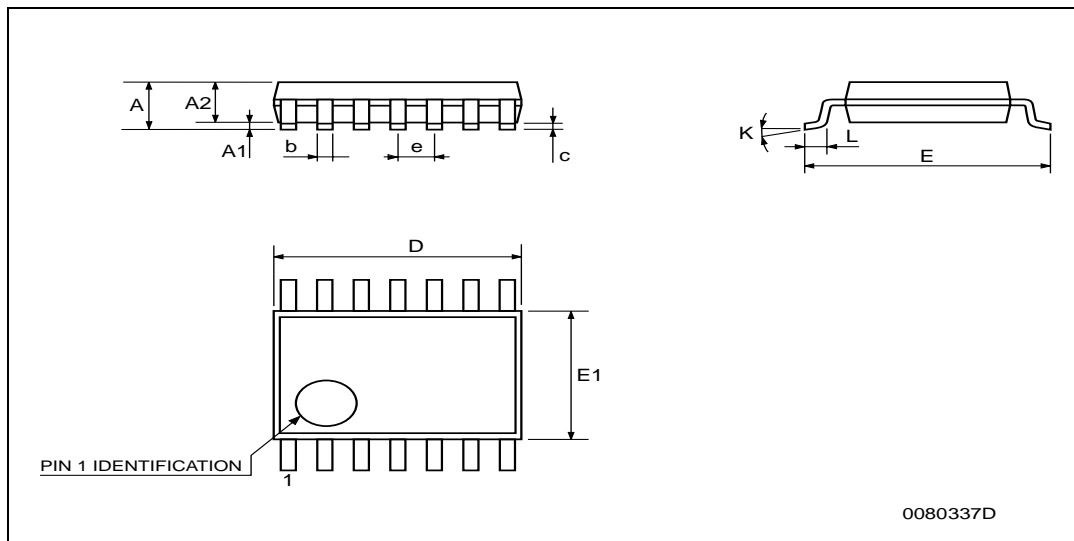

3.6 SOT23-5 package

SOT23-5L MECHANICAL DATA						
DIM.	mm.			mils		
	MIN.	TYP.	MAX.	MIN.	TYP.	MAX.
A	0.90		1.45	35.4		57.1
A1	0.00		0.15	0.0		5.9
A2	0.90		1.30	35.4		51.2
b	0.35		0.50	13.7		19.7
C	0.09		0.20	3.5		7.8
D	2.80		3.00	110.2		118.1
E	2.60		3.00	102.3		118.1
E1	1.50		1.75	59.0		68.8
e		0.95			37.4	
e1		1.9			74.8	
L	0.35		0.55	13.7		21.6

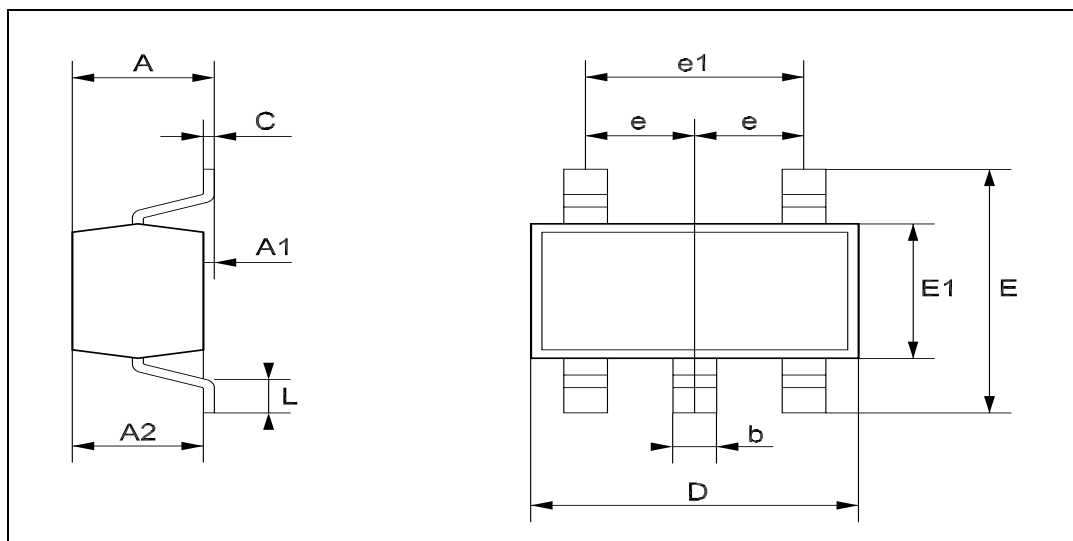

4 Summary of Changes

Date	Revision	Description of Changes
01 Nov 2001	1	First Release
01 Dec 2004	2	Modifications on AMR table page 2 (explanation of Vid and Vi limits)

Information furnished is believed to be accurate and reliable. However, STMicroelectronics assumes no responsibility for the consequences of use of such information nor for any infringement of patents or other rights of third parties which may result from its use. No license is granted by implication or otherwise under any patent or patent rights of STMicroelectronics. Specifications mentioned in this publication are subject to change without notice. This publication supersedes and replaces all information previously supplied. STMicroelectronics products are not authorized for use as critical components in life support devices or systems without express written approval of STMicroelectronics.

The ST logo is a registered trademark of STMicroelectronics
All other names are the property of their respective owners

© 2004 STMicroelectronics - All rights reserved

STMicroelectronics group of companies

Australia - Belgium - Brazil - Canada - China - Czech Republic - Finland - France - Germany - Hong Kong - India - Israel - Italy - Japan - Malaysia - Malta - Morocco - Singapore - Spain - Sweden - Switzerland - United Kingdom - United States of America

www.st.com