

Metallized Polyester Film Capacitors MKT Radial Epoxy Lacquered Type

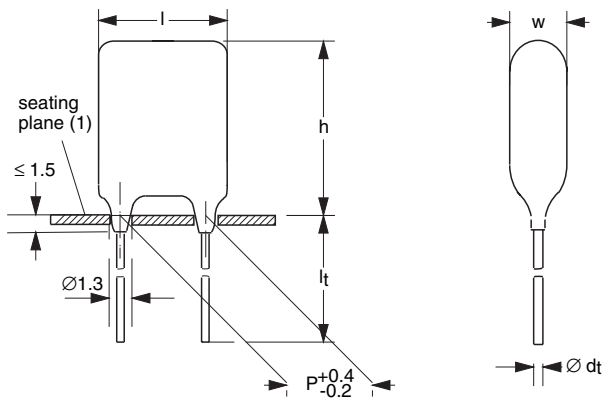

Dimensions in mm

(1) Hole $\varnothing 1.0$ for $d_t = 0.5$ mm

APPLICATIONS

Blocking and coupling. Bypass and energy reservoir

MARKING

C-value; tolerance; rated voltage

DIELECTRIC

Polyester film

ELECTRODES

Vacuum deposited aluminum

COATING

Flame retardant epoxy material (UL-class 94 V-0)

CONSTRUCTION

Wound mono construction

LEADS

Tinned wire

CAPACITANCE RANGE (E12 SERIES)

0.0033 to 1.0 μF

FEATURES

Available taped and loose in box

Lead (Pb)-free product

RoHS-compliant product

CAPACITANCE TOLERANCE

$\pm 10\%$; $\pm 5\%$

RATED (DC) VOLTAGE

63 V; 100 V; 250 V; 400 V

RATED (AC) VOLTAGE

40 V; 63 V; 160 V; 220 V

CLIMATIC CATEGORY

55/105/56

RATED TEMPERATURE

85 °C

MAXIMUM APPLICATION TEMPERATURE

105 °C

REFERENCE SPECIFICATIONS

IEC 60384-2

PERFORMANCE GRADE

Grade 1 (long life)

DETAIL SPECIFICATION

For more detailed data and test requirements contact:
filmcaps.roeselare@vishay.com



RoHS
COMPLIANT



Metallized Polyester Film Capacitors Vishay BCcomponents
MKT Radial Epoxy Lacquered Type

COMPOSITION OF CATALOG NUMBER

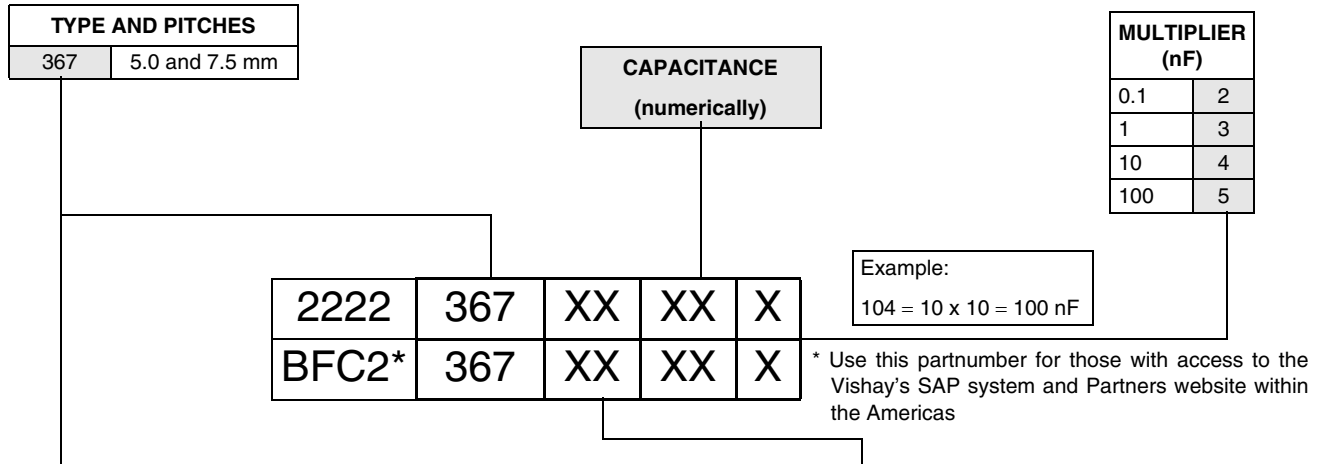

| TYPE | PACKAGING | LEAD CONFIGURATION | ON REQUEST | | | | |
|-----------------------|--------------|-----------------------------------|------------|------|-------|-------|-------|
| | | | C-TOL | 63 V | 100 V | 250 V | 400 V |
| Pitch = 5.0 mm | | | | | | | |
| 367 | ammopack | straight leads | ± 10 % | 73 | 83 | | |
| | | | ± 5 % | 77 | 87 | | |
| | loose in box | straight leads 4.0 + 1.0/- 0.5 mm | ± 10 % | 75 | 85 | - | - |
| | | | ± 5 % | 76 | 86 | - | - |
| | | straight leads 22.0 ± 4.0 mm | ± 10 % | 71 | 81 | - | - |
| | | | ± 5 % | 72 | 82 | - | - |
| Pitch = 7.5 mm | | | | | | | |
| ON REQUEST | | | | | | | |
| 367 | loose in box | straight leads 4.0 + 1.0/- 0.5 mm | ± 10 % | 15 | 25 | 45 | 55 |
| | | | ± 5 % | 16 | 26 | 46 | 56 |
| | | straight leads 22.0 ± 4.0 mm | ± 10 % | 11 | 21 | 41 | 51 |
| | | | ± 5 % | 12 | 22 | 42 | 52 |
| | ammopack | straight leads | ± 10 % | 13 | 23 | 43 | 53 |
| | | | ± 5 % | 17 | 27 | 47 | 57 |

SPECIFIC REFERENCE DATA

| DESCRIPTION | VALUE | | | |
|--|-------------------------|--------------------------|--------------------------|-----------------|
| | at 63 V (DC) | at 100 V (DC) | at 250 V (DC) | at 400 V (DC) |
| Tangent of loss angle: C ≤ 0.47 μF 0.47 μF < C ≤ 1.0 μF | at 1 kHz | at 10 kHz | at 100 kHz | |
| | ≤ 75 × 10 ⁻⁴ | ≤ 130 × 10 ⁻⁴ | ≤ 225 × 10 ⁻⁴ | |
| | ≤ 75 × 10 ⁻⁴ | ≤ 130 × 10 ⁻⁴ | - | |
| Rated voltage pulse slope (dU/dt) _R | at 63 V (DC) | at 100 V (DC) | at 250 V (DC) | at 400 V (DC) |
| | 110 V/μs | 110 V/μs | 130 V/μs | 170 V/μs |
| R between leads, for C ≤ 0.33 μF: at 10 V; 1 minute at 100 V; 1 minute | > 15000 MΩ | > 15000 MΩ | > 30000 MΩ | > 30000 MΩ |
| | > 5000 s | > 5000 s | | |
| RC between leads, for C > 0.33 μF at 10 V; 1 minute | > 30000 MΩ | > 30000 MΩ | >30000 MΩ | > 30000 MΩ |
| R between interconnecting leads and casing; 100 V; 1 minute | 100 V; 1 minute | 160 V; 1 minute | 400 V; 1 minute | 640 V; 1 minute |
| Withstanding (DC) voltage (cut off current 10 mA); rise time 100 V/s | | | | |

Vishay BCcomponents Metallized Polyester Film Capacitors
MKT Radial Epoxy Lacquered Type

$U_{Rdc} = 63 V$; $U_{Rac} = 40 V$

| C (μF) | DIMENSIONS $W_{max} \times H_{max} \times L_{max}$ (mm) | MASS (g) | CATALOG NUMBER 2222 367 AND PACKAGING | | | | | | |
|--|---|---------------------------------------|---|-------------------|---------------------------------------|---------------------------------------|--------------------|-------------------|------|
| | | | LOOSE IN BOX | | | | AMMOPACK | | |
| | | | It = 4.0 + 1.0/- 0.5 mm | | It = 22.0 \pm 4.0 mm | | H = 18.5 mm | | |
| | | | C-tol = $\pm 10\%$ | C-tol = $\pm 5\%$ | SPQ | SPQ | C-TOL = $\pm 10\%$ | C-TOL = $\pm 5\%$ | SPQ |
| | last 5 digits of catalog number | last 5 digits of catalog number | | | last 5 digits of catalog number | last 5 digits of catalog number | | | |
| Pitch = 5.0 + 0.4/- 0.2 mm; $d_t = 0.50 \pm 0.05$ mm | | | | | | | | | |
| 0.047 | 4.0 \times 9.5 \times 7.3 | 0.3 | 75473 | 76473 | 1000 | 1000 | 73473 | 77473 | 1500 |
| 0.056 | | | 75563 | 76563 | | | 73563 | 77563 | |
| 0.068 | | | 75683 | 76683 | | | 73683 | 77683 | |
| 0.082 | | | 75823 | 76823 | | | 73823 | 77823 | |
| 0.1 | | | 75104 | 76104 | | | 73104 | 77104 | |
| 0.12 | | | 75124 | 76124 | | | 73124 | 77124 | |
| 0.15 | 4.0 \times 9.5 \times 7.3 | 0.3 | 75154 | 76154 | 1000 | 1000 | 73154 | 77154 | 1500 |
| 0.18 | 4.0 \times 9.5 \times 7.3 | 0.4 | 75184 | 76184 | 1000 | 1000 | 73184 | 77184 | 1500 |
| 0.22 | 4.2 \times 9.7 \times 7.3 | 0.4 | 75224 | 76224 | 1000 | 1000 | 73224 | 77224 | 1000 |
| 0.27 | 4.5 \times 10.0 \times 7.3 | 0.4 | 75274 | 76274 | 1000 | 1000 | 73274 | 77274 | 1000 |
| 0.33 | 4.5 \times 11.0 \times 7.3 | 0.4 | 75334 | 76334 | 1000 | 1000 | 73334 | 77334 | 1000 |
| 0.39 | | | 75394 | 76394 | | | 73394 | 77394 | |
| 0.47 | 4.5 \times 11.0 \times 7.3 | 0.4 | 75474 | 76474 | 1000 | 1000 | 73474 | 77474 | 1000 |
| 0.56 | 5.0 \times 10.5 \times 7.3 | 0.4 | 75564 | 76564 | 1000 | 1000 | 73564 | 77564 | 1000 |
| 0.68 | 5.5 \times 11.0 \times 7.3 | 0.4 | 75684 | 76684 | 1000 | 1000 | 73684 | 77684 | 1000 |
| 0.82 | 5.5 \times 12.0 \times 7.3 | 0.5 | 75824 | 76824 | 1000 | 1000 | 73824 | 77824 | 1000 |
| 1.0 | 5.5 \times 12.0 \times 7.3 | 0.5 | 75105 | 76105 | 1000 | 1000 | 73105 | 77105 | 1000 |
| Pitch = 7.5 + 0.4/- 0.2 mm; $d_t = 0.60 \pm 0.06$ mm | | | | | | | | | |
| 0.12 | 4.0 \times 9.5 \times 10.0 | 0.4 | 15124 | 16124 | 1000 | 1000 | 13124 | 17124 | 1500 |
| 0.15 | | | 15154 | 16154 | | | 13154 | 17154 | |
| 0.18 | | | 15184 | 16184 | | | 13184 | 17184 | |
| 0.22 | | | 15224 | 16224 | | | 13224 | 17224 | |
| 0.27 | 4.5 \times 10.0 \times 10.5 | 0.5 | 15274 | 16274 | 1000 | 1000 | 13274 | 17274 | 1000 |
| 0.33 | 5.0 \times 10.5 \times 10.5 | 0.5 | 15334 | 16334 | 1000 | 1000 | 13334 | 17334 | 1000 |
| 0.39 | | 0.6 | 15394 | 16394 | | | 13394 | 17394 | |
| 0.47 | 5.5 \times 11.0 \times 10.5 | 0.7 | 15474 | 16474 | 1000 | 1000 | 13474 | 17474 | 1000 |
| 0.56 | 5.5 \times 12.0 \times 10.5 | 0.8 | 15564 | 16564 | 1000 | 1000 | 13564 | 17564 | 1000 |
| 0.68 | | | 15684 | 16684 | | | 13684 | 17684 | |
| 0.82 | | | 15824 | 16824 | | | 13824 | 17824 | |
| 1.0 | | | 15105 | 16105 | | | 13105 | 17105 | |



Metallized Polyester Film Capacitors Vishay BCcomponents
MKT Radial Epoxy Lacquered Type

$U_{Rdc} = 100\text{ V}$; $U_{Rac} = 63\text{ V}$

| C (μF) | DIMENSIONS $W_{max} \times H_{max} \times L_{max}$ (mm) | MASS (g) | CATALOG NUMBER 2222 367 AND PACKAGING | | | | | | | | |
|---|---|-------------|---|-------|---------------------------------------|-----------------------|----------|-------------|---------------------------------------|---------------------------------------|------|
| | | | LOOSE IN BOX | | | | AMMOPACK | | | | |
| | | | It = 4.0 + 1.0/- 0.5 mm | | | It = 22.0 ± 4.0 mm | | H = 18.5 mm | | | |
| | | | C-tol = ± 10 % | | C-tol = ± 5 % | SPQ | SPQ | | C-TOL = ± 10 % | C-TOL = ± 5 % | SPQ |
| | | | last 5 digits of catalog number | | last 5 digits of catalog number | SPQ | SPQ | | last 5 digits of catalog number | last 5 digits of catalog number | SPQ |
| Pitch = 5.0 + 0.4/- 0.2 mm; $d_t = 0.50 \pm 0.05\text{ mm}$ | | | | | | | | | | | |
| 0.01 | 4.0 × 9.5 × 7.3 | 0.3 | 85103 | 86103 | 1000 | 1000 | 83103 | 87103 | 1500 | | |
| 0.012 | | | 85123 | 86123 | | | 83123 | 87123 | | | |
| 0.015 | | | 85153 | 86153 | | | 83153 | 87153 | | | |
| 0.018 | | | 85183 | 86183 | | | 83183 | 87183 | | | |
| 0.022 | | | 85223 | 86223 | | | 83223 | 87223 | | | |
| 0.027 | | | 85273 | 86273 | | | 83273 | 87273 | | | |
| 0.033 | | | 85333 | 86333 | | | 83333 | 87333 | | | |
| 0.039 | | | 85393 | 86393 | | | 83393 | 87393 | | | |
| 0.047 | | | 4.5 × 10.0 × 7.3 | 0.3 | | | 85473 | 86473 | | 1000 | 1000 |
| 0.056 | 85563 | 86563 | | | 83563 | 87563 | | | | | |
| 0.068 | 85683 | 86683 | | | 83683 | 87683 | | | | | |
| 0.082 | 4.5 × 10.0 × 7.3 | 0.3 | 85823 | 86823 | 1000 | 1000 | 83823 | 87823 | 1500 | | |
| 0.1 | 4.5 × 10.0 × 7.3 | 0.4 | 85104 | 86104 | 1000 | 1000 | 83104 | 87104 | 1500 | | |
| 0.12 | | | 85124 | 86124 | | | 83124 | 87124 | | | |
| 0.15 | | | 85154 | 86154 | | | 83154 | 87154 | | | |
| 0.18 | | | 85184 | 86184 | | | 83184 | 87184 | | | |
| 0.22 | 4.5 × 10.0 × 7.3 | 0.4 | 85224 | 86224 | 1000 | 1000 | 83224 | 87224 | 1000 | | |
| 0.27 | 4.5 × 10.0 × 7.3 | 0.4 | 85274 | 86274 | 1000 | 1000 | 83274 | 87274 | 1000 | | |
| Pitch = 7.5 + 0.4/- 0.2 mm; $d_t = 0.60 \pm 0.06\text{ mm}$ | | | | | | | | | | | |
| 0.039 | 4.0 × 9.5 × 10.0 | 0.4 | 25393 | 26393 | 1000 | 1000 | 23393 | 27393 | 1500 | | |
| 0.047 | | | 25473 | 26473 | | | 23473 | 27473 | | | |
| 0.056 | | | 25563 | 26563 | | | 23563 | 27563 | | | |
| 0.068 | | | 25683 | 26683 | | | 23683 | 27683 | | | |
| 0.082 | | | 25823 | 26823 | | | 23823 | 27823 | | | |
| 0.1 | 4.0 × 9.5 × 10.0 | 0.4 | 25104 | 26104 | 1000 | 1000 | 23104 | 27104 | 1500 | | |
| 0.12 | 4.5 × 10.0 × 10.5 | 0.5 | 25124 | 26124 | 1000 | 1000 | 23124 | 27124 | 1000 | | |
| 0.15 | 5.0 × 10.5 × 10.5 | 0.5 | 25154 | 26154 | 1000 | 1000 | 23154 | 27154 | 1000 | | |
| 0.18 | | 0.6 | 25184 | 26184 | | | 23184 | 27184 | | | |
| 0.22 | 5.5 × 11.5 × 10.5 | 0.7 | 25224 | 26224 | 1000 | 1000 | 23224 | 27224 | 1000 | | |
| 0.27 | 6.0 × 12.5 × 10.5 | 0.7 | 25274 | 26274 | 1000 | 1000 | 23274 | 27274 | 1000 | | |
| 0.33 | | | 25334 | 26334 | | | 23334 | 27334 | | | |
| 0.39 | | | 25394 | 26394 | | | 23394 | 27394 | | | |
| 0.47 | | | 25474 | 26474 | | | 23474 | 27474 | | | |

$U_{Rdc} = 250\text{ V}$; $U_{Rac} = 16\text{ V}$

| C (μF) | DIMENSIONS $W_{max} \times H_{max} \times L_{ma}$ x (mm) | MASS (g) | CATALOG NUMBER 2222 367 AND PACKAGING | | | | | | |
|---|---|-------------|---|---------------------------------------|---------------------------|------|---------------------------------------|---------------------------------------|------|
| | | | LOOSE IN BOX | | | | AMMOPACK | | |
| | | | It = 4.0 + 1.0/- 0.5 mm | | It = 22.0 \pm 4.0 mm | | H = 18.5 mm | | |
| | | | C-tol = $\pm 10\%$ | C-tol = $\pm 5\%$ | SPQ | SPQ | C-TOL = $\pm 10\%$ | C-TOL = $\pm 5\%$ | SPQ |
| | | | last 5 digits of catalog number | last 5 digits of catalog number | | | last 5 digits of catalog number | last 5 digits of catalog number | |
| Pitch = 7.5 +0.4/-0.2 mm; $d_t = 0.60 \pm 0.06\text{ mm}$ | | | | | | | | | |
| 0.018 | 4.0 x 9.5 x 10.0 | 0.4 | 45183 | 46183 | 1000 | 1000 | 43183 | 47183 | 1500 |
| 0.022 | | | 45223 | 46223 | | | 43223 | 47223 | |
| 0.027 | | | 45273 | 46273 | | | 43273 | 47273 | |
| 0.033 | | | 45333 | 46333 | | | 43333 | 47333 | |
| 0.039 | | | 45393 | 46393 | | | 43393 | 47393 | |
| 0.047 | | | 45473 | 46473 | | | 43473 | 47473 | |
| 0.056 | 4.0 x 9.5 x 10.0 | 0.7 | 45563 | 46563 | 1000 | 1000 | 43563 | 47563 | 1500 |
| 0.068 | 4.5 x 10.0 x 10.0 | 0.7 | 45683 | 46683 | 1000 | 1000 | 43683 | 47683 | 1000 |
| 0.082 | 4.5 x 10.0 x 10.0 | 0.5 | 45823 | 46823 | 1000 | 1000 | 43823 | 47823 | 1000 |
| 0.1 | 5.0 x 10.5 x 10.0 | 0.6 | 45104 | 46104 | 1000 | 1000 | 43104 | 47104 | 1000 |
| 0.12 | 5.5 x 11.0 x 10.0 | 0.6 | 45124 | 46124 | 1000 | 1000 | 43124 | 47124 | 1000 |
| 0.15 | 5.5 x 12.5 x 10.0 | 0.7 | 45154 | 46154 | 1000 | 1000 | 43154 | 47154 | 1000 |

$U_{Rdc} = 400\text{ V}$; $U_{Rac} = 220\text{ V}$

| C (μF) | DIMENSIONS $W_{max} \times H_{max} \times L_{ma}$ x (mm) | MASS (g) | CATALOG NUMBER 2222 367 AND PACKAGING | | | | | | |
|---|---|-------------|---|---------------------------------------|---------------------------|------|---------------------------------------|---------------------------------------|------|
| | | | LOOSE IN BOX | | | | AMMOPACK | | |
| | | | It = 4.0 + 1.0/- 0.5 mm | | It = 22.0 \pm 4.0 mm | | H = 18.5 mm | | |
| | | | C-tol = $\pm 10\%$ | C-tol = $\pm 5\%$ | SPQ | SPQ | C-TOL = $\pm 10\%$ | C-TOL = $\pm 5\%$ | SPQ |
| | | | last 5 digits of catalog number | last 5 digits of catalog number | | | last 5 digits of catalog number | last 5 digits of catalog number | |
| Pitch = 7.5 +0.4/-0.2 mm; $d_t = 0.60 \pm 0.06\text{ mm}$ | | | | | | | | | |
| 0.0033 | 4.0 x 9.5 x 10.0 | 0.4 | 55332 | 56332 | 1000 | 1000 | 53332 | 57332 | 1500 |
| 0.0039 | | | 55392 | 56392 | | | 53392 | 57392 | |
| 0.0047 | | | 55472 | 56472 | | | 53472 | 57472 | |
| 0.0056 | | | 55562 | 56562 | | | 53562 | 57562 | |
| 0.0068 | | | 55682 | 56682 | | | 53682 | 57682 | |
| 0.0082 | | | 55822 | 56822 | | | 53822 | 57822 | |
| 0.01 | | | 55103 | 56103 | | | 53103 | 57103 | |
| 0.012 | | | 55123 | 56123 | | | 53123 | 57123 | |
| 0.015 | | | 55153 | 56153 | | | 53153 | 57153 | |
| 0.018 | | | 4.5 x 10.0 x 10.0 | 0.6 | | | 55183 | 56183 | |
| 0.022 | 5.0 x 10.5 x 10.0 | 0.7 | 55223 | 56223 | 1000 | 1000 | 53223 | 57223 | 1000 |
| 0.027 | 4.0 x 9.5 x 10.0 | 0.4 | 55273 | 56273 | 1000 | 1000 | 53273 | 57273 | 1500 |
| 0.033 | 4.5 x 10.0 x 10.0 | 0.5 | 55333 | 56333 | 1000 | 1000 | 53333 | 57333 | 1000 |
| 0.039 | 5.0 x 10.5 x 10.0 | 0.5 | 55393 | 56393 | 1000 | 1000 | 53393 | 57393 | 1000 |
| 0.047 | 5.0 x 10.5 x 10.0 | 0.6 | 55473 | 56473 | 1000 | 1000 | 53473 | 57473 | 1000 |
| 0.056 | 5.5 x 11.0 x 10.0 | 0.7 | 55563 | 56563 | 1000 | 1000 | 53563 | 57563 | 1000 |



Metallized Polyester Film Capacitors Vishay BCcomponents
MKT Radial Epoxy Lacquered Type

MAXIMUM RMS VOLTAGE (SENEWAVE) AS A FUNCTION OF FREQUENCY

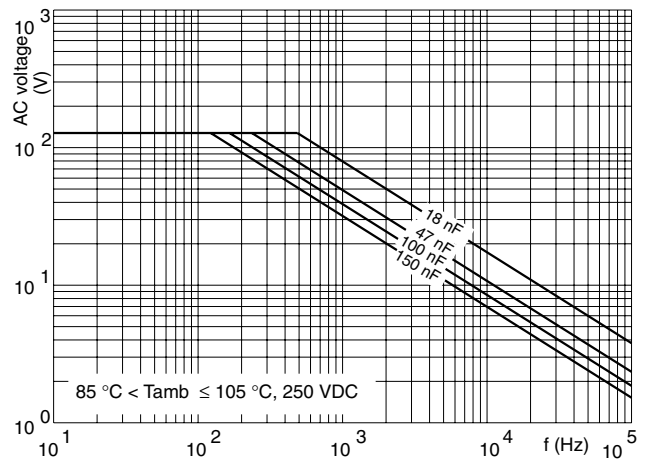
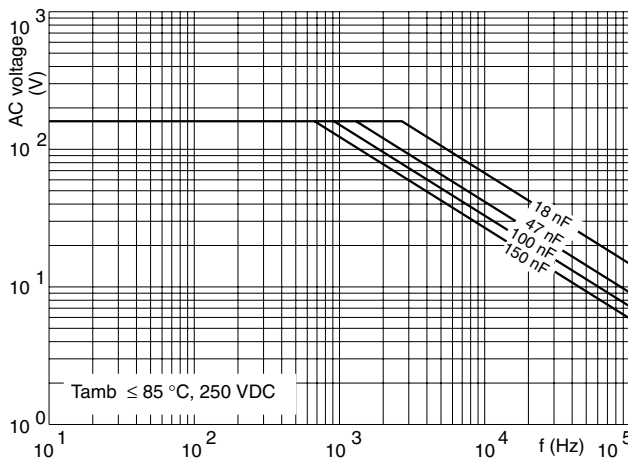
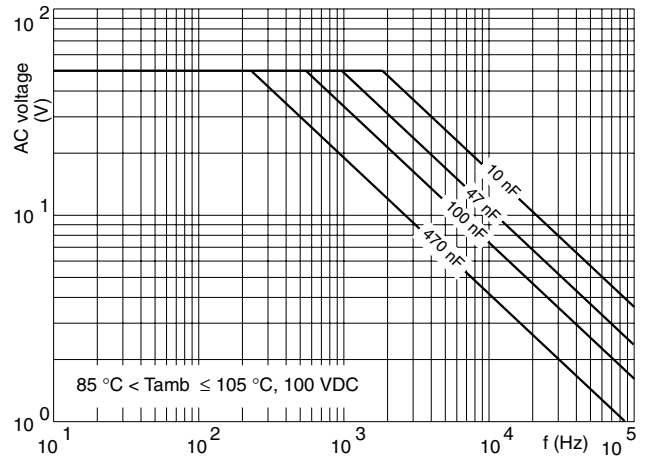
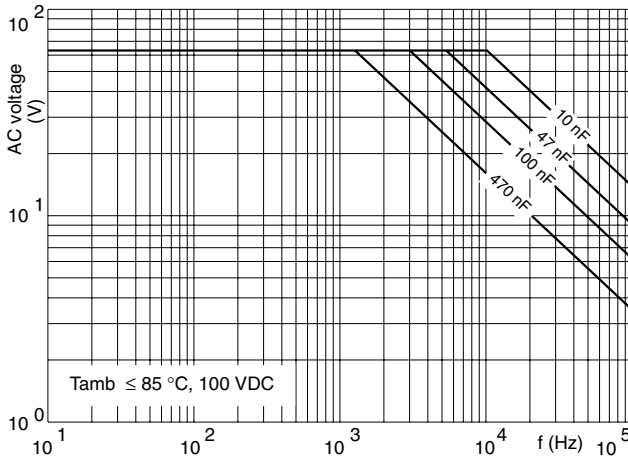
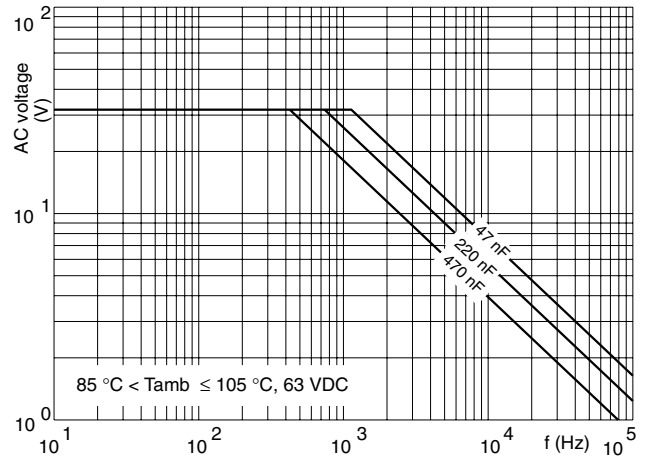
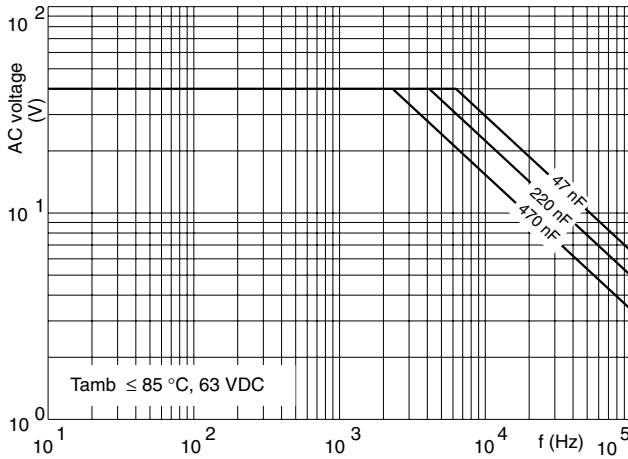

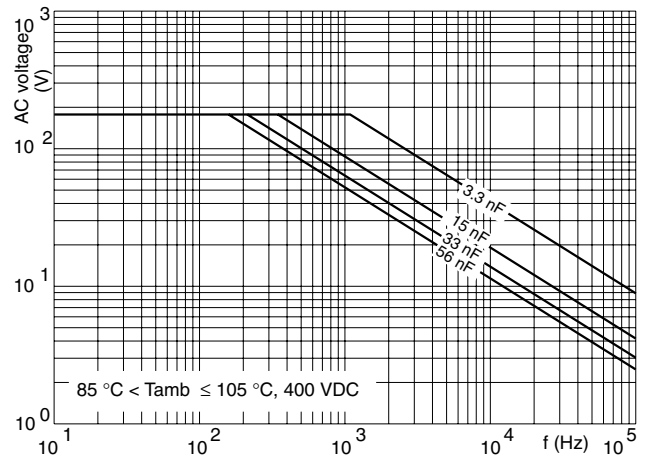
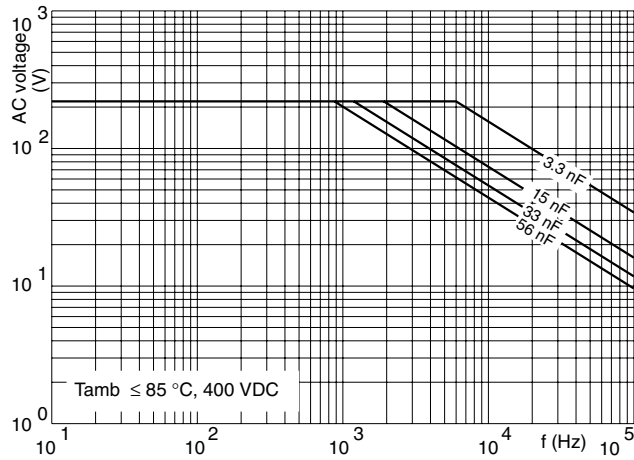

CAPACITANCE

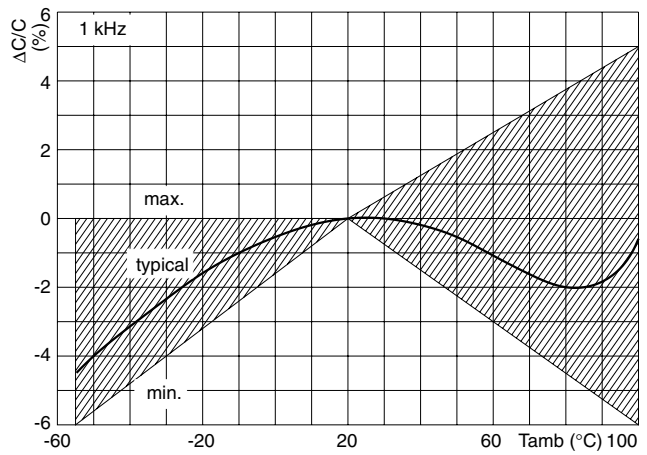
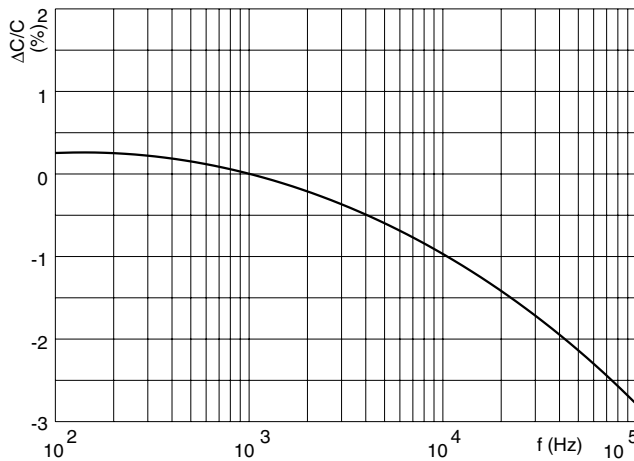

IMPEDANCE

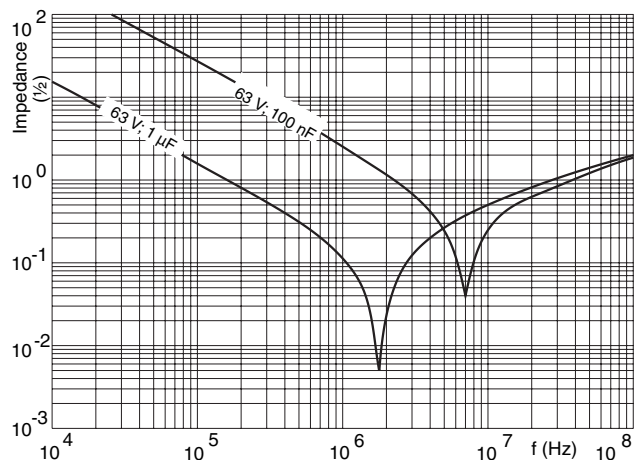



Disclaimer

All product specifications and data are subject to change without notice.

Vishay Intertechnology, Inc., its affiliates, agents, and employees, and all persons acting on its or their behalf (collectively, "Vishay"), disclaim any and all liability for any errors, inaccuracies or incompleteness contained herein or in any other disclosure relating to any product.

Vishay disclaims any and all liability arising out of the use or application of any product described herein or of any information provided herein to the maximum extent permitted by law. The product specifications do not expand or otherwise modify Vishay's terms and conditions of purchase, including but not limited to the warranty expressed therein, which apply to these products.

No license, express or implied, by estoppel or otherwise, to any intellectual property rights is granted by this document or by any conduct of Vishay.

The products shown herein are not designed for use in medical, life-saving, or life-sustaining applications unless otherwise expressly indicated. Customers using or selling Vishay products not expressly indicated for use in such applications do so entirely at their own risk and agree to fully indemnify Vishay for any damages arising or resulting from such use or sale. Please contact authorized Vishay personnel to obtain written terms and conditions regarding products designed for such applications.

Product names and markings noted herein may be trademarks of their respective owners.