

DC Film Capacitor MKT Radial Lacquered Type

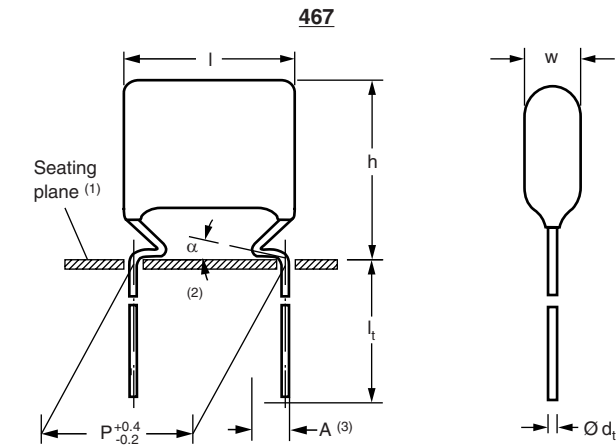

Notes

- (1) Hole \varnothing 1.0 for $d_t = 0.6$ mm
- (2) $0 \leq \alpha < 50^\circ$
- (3) $A = 2.0 \pm 0.5$ mm

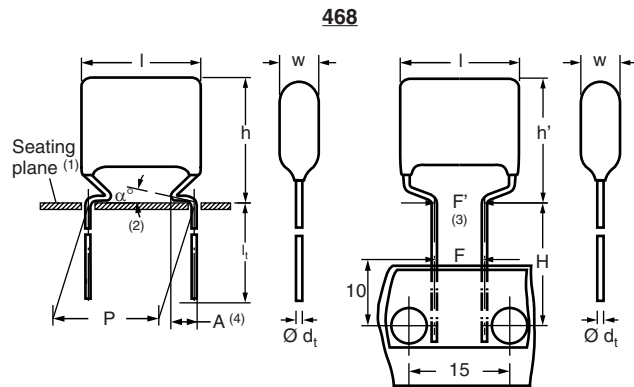

Notes

- (1) Hole \varnothing 1.0 for $d_t = 0.8$ mm
- (2) $0 \leq \alpha < 50^\circ$
- (3) $|F - F'| < 0.3$ mm
 $F = 7.5 + 0.6/-0.1$
- (4) $A = 2.5 + 1.4/-0.5 \pm 0.3$ mm

469 Straight Leads

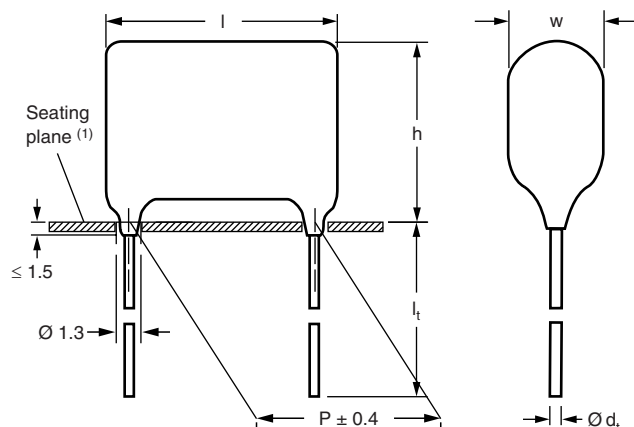

Note

- (1) Hole \varnothing 1.0 for $d_t = 0.6$ mm

FEATURES

Available taped and loose in box
RoHs compliant



APPLICATIONS

Blocking and coupling, bypass and energy reservoir.



RoHS
COMPLIANT

REFERENCE STANDARDS

IEC 60384-2

MARKING

C-value; tolerance; rated voltage; code for manufacturer; manufacturer's type; manufacturer's logo

DIELECTRIC

Polyester film

ELECTRODES

Metallized

CONSTRUCTION

Mono construction

RATED (DC) VOLTAGE

100 V, 250 V, 400 V, 630 V

RATED (AC) VOLTAGE

63 V, 160 V, 220 V, 250 V

ENCAPSULATION

Flame retardant epoxy material (UL-class 94 V-0)

CLIMATIC TESTING CLASS ACC. TO IEC 60068-1

55/105/56

RATED TEMPERATURE

85 °C

CAPACITANCE RANGE (E12 SERIES)

467: 0.001 μ F to 1.0 μ F

468: 0.001 μ F to 10.0 μ F

469: 0.001 μ F to 1.0 μ F

CAPACITANCE TOLERANCE

$\pm 10 \%$, $\pm 5 \%$

LEADS

Tinned wire

MAXIMUM APPLICATION TEMPERATURE

105 °C

DETAIL SPECIFICATION

For more detailed data and test requirements contact:
dc-film@vishay.com



COMPOSITION OF CATALOG NUMBER: 467

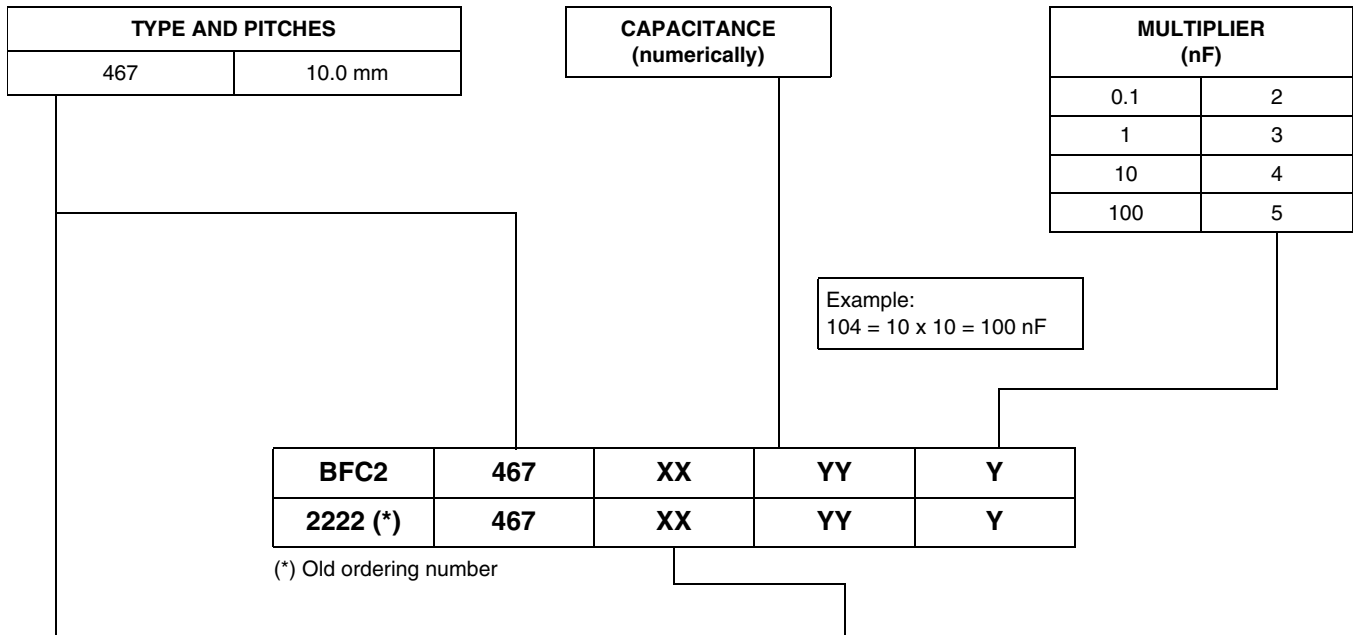

| TYPE | PACKAGING | LEAD CONFIGURATION | PREFERRED TYPES | | | | |
|---------|-------------------|---|-----------------|-------|-------|-------|-------|
| | | | C-TOL. | 100 V | 250 V | 400 V | 630 V |
| MKT 467 | Loose in box | Lead length 3.5 + 1.0/- 0.5 mm | ± 10 % | 04 | 16 | 28 | 40 |
| | | | ± 5 % | 05 | 17 | 29 | 41 |
| | | Lead length 19.0 ± 4.0 mm | ± 10 % | 51 | 53 | 55 | 57 |
| | | | ± 5 % | 52 | 54 | 56 | 58 |
| | Taped on reel (1) | H = 16.0 mm; P ₀ = 12.7 mm Reel diameter = 500 mm | ± 10 % | 06 | 18 | 30 | 42 |
| | | | ± 5 % | 07 | 19 | 31 | 43 |

Notes

(1) For detailed tape specifications refer to packaging information: www.vishay.com/docs/28139/packinfo.pdf or end of catalogue

(2) SPQ = Standard Packaging Quantity

SPECIFIC REFERENCE DATA: 467

| DESCRIPTION | VALUE | | | |
|---|-------------------------|--------------------------|--------------------------|---------------|
| | at 1 kHz | at 10 kHz | at 100 kHz | |
| Tangent of loss angle: | | | | |
| C ≤ 0.1 μF | ≤ 75 x 10 ⁻⁴ | ≤ 120 x 10 ⁻⁴ | ≤ 200 x 10 ⁻⁴ | |
| 0.1 μF < C ≤ 0.47 μF | ≤ 75 x 10 ⁻⁴ | ≤ 120 x 10 ⁻⁴ | ≤ 225 x 10 ⁻⁴ | |
| 0.47 μF < C ≤ 1.0 μF | ≤ 75 x 10 ⁻⁴ | ≤ 120 x 10 ⁻⁴ | - | |
| Rated voltage pulse slope (dU/dt) _R at I _{max.} = 12.5 mm | 100 Vdc | 250 Vdc | 400 Vdc | 630 Vdc |
| | 30 V/μs | 120 V/μs | 170 V/μs | 120 V/μs |
| R between leads, for C ≤ 0.33 μF | | | | |
| at 100 V; 1 min | > 15 000 MΩ | > 30 000 MΩ | > 30 000 MΩ | |
| at 500 V; 1 min | | | | > 30 000 MΩ |
| R between leads, for C > 0.33 μF | | | | |
| at 100 V; 1 min | > 5000 s | > 10 000 s | > 10 000 s | |
| at 500 V; 1 min | | | | > 10 000 s |
| R between interconnecting leads and casing, | | | | |
| at 100 V; 1 min | > 30 000 MΩ | | | |
| at 500 V; 1 min | | | | |
| Withstanding (DC) voltage (cut off current 10 mA); rise time 100 V/s | 160 V; 1 min | 400 V; 1 min | 640 V; 1 min | 1008 V; 1 min |
| Withstanding (DC) voltage between leads and case | 200 V; 1 min | 500 V; 1 min | 800 V; 1 min | 1260 V; 1 min |
| Maximum application temperature | 105 °C | | | |

$U_{Rdc} = 100\text{ V}$; $U_{Rac} = 63\text{ V}$

| C (μF) | DIMENSIONS $w_{max.} \times h_{max.} \times l_{max.}$ (mm) | MASS (g) ⁽¹⁾ | CATALOG NUMBER BFC2 467..... AND PACKAGING | | | | | | | C-VALUE ..YYY |
|--|--|----------------------------|--|-----------------------|--------------------------------|-----------------------|--|-----------------------|--------------------------|----------------------|
| | | | LOOSE IN BOX | | | | REEL | | C-tol. = $\pm 5\%$ | |
| | | | $l_t = 3.5 + 1.0/-0.5\text{ mm}$ | | $l_t = 19.0 \pm 4.0\text{ mm}$ | | H = 16.0 mm; P ₀ = 12.7 mm | | | |
| | | | C-tol. = $\pm 10\%$ | C-tol. = $\pm 5\%$ | C-tol. = $\pm 10\%$ | C-tol. = $\pm 5\%$ | C-tol. = $\pm 10\%$ | C-tol. = $\pm 5\%$ | | |
| | | | XX (SPQ) | XX (SPQ) | XX (SPQ) | XX (SPQ) | XX (SPQ) | XX (SPQ) | | |
| Pitch = 10.0 \pm 0.4 mm; d _t = 0.60 \pm 0.06 mm | | | | | | | | | | |
| 0.056 0.068 0.082 0.1 | 4.0 x 14.0 x 12.5 | 0.37 | 04... (2000) | 05... (2000) | 51... (1500) | 52... (1500) | 06... (1500) | 07... (1500) | 563 683 823 104 | |
| 0.12 | 4.3 x 14.3 x 12.5 | 0.40 | 04... (2000) | 05... (2000) | 51... (1500) | 52... (1500) | 06... (1500) | 07... (1500) | 124 | |
| 0.15 | 4.0 x 14.0 x 12.5 | 0.37 | 04... (2000) | 05... (2000) | 51... (1500) | 52... (1500) | 06... (1500) | 07... (1500) | 154 | |
| 0.18 | 4.2 x 14.2 x 12.5 | 0.39 | 04... (2000) | 05... (2000) | 51... (1500) | 52... (1500) | 06... (1500) | 07... (1500) | 184 | |
| 0.22 | 4.5 x 14.6 x 12.5 | 0.43 | 04... (2000) | 05... (2000) | 51... (1500) | 52... (1500) | 06... (1300) | 07... (1300) | 224 | |
| 0.27 | 4.2 x 14.2 x 12.5 | 0.39 | 04... (2000) | 05... (2000) | 51... (1500) | 52... (1500) | 06... (1500) | 07... (1500) | 274 | |
| 0.33 | 4.6 x 14.6 x 12.5 | 0.44 | 04... (2000) | 05... (2000) | 51... (1500) | 52... (1500) | 06... (1300) | 07... (1300) | 334 | |
| 0.39 | 4.0 x 14.0 x 12.5 | 0.37 | 04... (2000) | 05... (2000) | 51... (1500) | 52... (1500) | 06... (1500) | 07... (1500) | 394 | |
| 0.47 | 4.2 x 14.2 x 12.5 | 0.39 | 04... (2000) | 05... (2000) | 51... (1500) | 52... (1500) | 06... (1500) | 07... (1500) | 474 | |
| 0.56 | 4.6 x 14.6 x 12.5 | 0.44 | 04... (2000) | 05... (2000) | 51... (1500) | 52... (1500) | 06... (1300) | 07... (1300) | 564 | |
| 0.68 | 5.0 x 15.0 x 12.5 | 0.50 | 04... (1500) | 05... (1500) | 51... (1250) | 52... (1250) | 06... (1200) | 07... (1200) | 684 | |
| 0.82 | 5.5 x 15.5 x 12.5 | 0.60 | 04... (1500) | 05... (1500) | 51... (1000) | 52... (1000) | 06... (1100) | 07... (1100) | 824 | |
| 1.0 | 6.0 x 16.0 x 12.5 | 0.75 | 04... (1250) | 05... (1250) | 51... (1000) | 52... (1000) | 06... (1000) | 07... (1000) | 105 | |

Note

⁽¹⁾ Net weight for short lead product only



DC Film Capacitor
MKT Radial Lacquered Type

Vishay BCcomponents

$U_{Rdc} = 250\text{ V}$; $U_{Rac} = 160\text{ V}$

| C (μF) | DIMENSIONS $w_{max.} \times h_{max.} \times l_{max.}$ (mm) | MASS (g) ⁽¹⁾ | CATALOG NUMBER BFC2 467..... AND PACKAGING | | | | | | | C-VALUE ..YYY |
|--|--|----------------------------|--|-----------------------|--------------------------------|-----------------------|--|-----------------------|-----|----------------------|
| | | | LOOSE IN BOX | | | | REEL | | | |
| | | | $l_t = 3.5 + 1.0/-0.5\text{ mm}$ | | $l_t = 19.0 \pm 4.0\text{ mm}$ | | H = 16.0 mm; P ₀ = 12.7 mm | | | |
| | | | C-tol. = $\pm 10\%$ | C-tol. = $\pm 5\%$ | C-tol. = $\pm 10\%$ | C-tol. = $\pm 5\%$ | C-tol. = $\pm 10\%$ | C-tol. = $\pm 5\%$ | | |
| | | | XX (SPQ) | XX (SPQ) | XX (SPQ) | XX (SPQ) | XX (SPQ) | XX (SPQ) | | |
| Pitch = 10.0 \pm 0.4 mm; d_t = 0.60 \pm 0.06 mm | | | | | | | | | | |
| 0.027 | 4.2 x 14.2 x 12.5 | 0.39 | 16... (2000) | 17... (2000) | 53... (1500) | 54... (1500) | 18... (1500) | 19... (1500) | 273 | |
| 0.033 | 4.6 x 14.6 x 12.5 | 0.44 | 16... (2000) | 17... (2000) | 53... (1500) | 54... (1500) | 18... (1300) | 19... (1300) | 333 | |
| 0.039 | 4.0 x 14.0 x 12.5 | 0.37 | 16... (2000) | 17... (2000) | 53... (1500) | 54... (1500) | 18... (1500) | 19... (1500) | 393 | |
| 0.047 | 4.1 x 14.1 x 12.5 | 0.38 | 16... (2000) | 17... (2000) | 53... (1500) | 54... (1500) | 18... (1500) | 19... (1500) | 473 | |
| 0.056 | 4.0 x 14.0 x 12.5 | 0.37 | 16... (2000) | 17... (2000) | 53... (1500) | 54... (1500) | 18... (1500) | 19... (1500) | 563 | |
| 0.068 | 4.1 x 14.1 x 12.5 | 0.38 | 16... (2000) | 17... (2000) | 53... (1500) | 54... (1500) | 18... (1500) | 19... (1500) | 683 | |
| 0.082 | 4.4 x 14.4 x 12.5 | 0.41 | 16... (2000) | 17... (2000) | 53... (1500) | 54... (1500) | 18... (1500) | 19... (1500) | 823 | |
| 0.1 | 4.0 x 14.0 x 12.5 | 0.37 | 16... (2000) | 17... (2000) | 53... (1500) | 54... (1500) | 18... (1500) | 19... (1500) | 104 | |
| 0.12 | 4.3 x 14.3 x 12.5 | 0.40 | 16... (2000) | 17... (2000) | 53... (1500) | 54... (1500) | 18... (1500) | 19... (1500) | 124 | |
| 0.15 | 4.8 x 14.8 x 12.5 | 0.48 | 16... (2000) | 17... (2000) | 53... (1250) | 54... (1250) | 18... (1300) | 19... (1300) | 154 | |
| 0.18 | 5.2 x 15.2 x 12.5 | 0.52 | 16... (1500) | 17... (1500) | 53... (1000) | 54... (1000) | 18... (1200) | 19... (1200) | 184 | |
| 0.22 | 5.8 x 15.8 x 12.5 | 0.67 | 16... (1500) | 17... (1500) | 53... (1000) | 54... (1000) | 18... (1100) | 19... (1100) | 224 | |

Note

⁽¹⁾ Net weight for short lead product only

$U_{Rdc} = 400\text{ V}$; $U_{Rac} = 220\text{ V}$

| C (μF) | DIMENSIONS $w_{max.} \times h_{max.} \times l_{max.}$ (mm) | MASS (g) ⁽¹⁾ | CATALOG NUMBER BFC2 467..... AND PACKAGING | | | | | | C-VALUE ..YYY |
|---|--|----------------------------|--|-----------------------|--------------------------------|-----------------------|--|-----------------------|----------------------|
| | | | LOOSE IN BOX | | | | REEL | | |
| | | | $l_t = 3.5 + 1.0/- 0.5\text{ mm}$ | | $l_t = 19.0 \pm 4.0\text{ mm}$ | | H = 16.0 mm; P ₀ = 12.7 mm | | |
| | | | C-tol. = $\pm 10\%$ | C-tol. = $\pm 5\%$ | C-tol. = $\pm 10\%$ | C-tol. = $\pm 5\%$ | C-tol. = $\pm 10\%$ | C-tol. = $\pm 5\%$ | |
| | | | | XX (SPQ) | XX (SPQ) | XX (SPQ) | XX (SPQ) | | |
| Pitch = 10.0 \pm 0.4 mm; $d_t = 0.60 \pm 0.06\text{ mm}$ | | | | | | | | | |
| 0.001 | 4.5 x 14.5 x 12.5 | 0.43 | 28... | 29... | 55... | 56... | 30... | 31... | 102 |
| 0.0012 | | | (2000) | (2000) | (1500) | (1500) | (1300) | (1300) | 122 |
| 0.0015 | | | | | | | | | 152 |
| 0.0018 | | | | | | | | | 182 |
| 0.0022 | 4.0 x 14.0 x 12.5 | 0.37 | 28... (2000) | 29... (2000) | 55... (1500) | 56... (1500) | 30... (1500) | 31... (1500) | 222 |
| 0.0027 | 4.3 x 14.3 x 12.5 | 0.40 | 28... (2000) | 29... (2000) | 55... (1500) | 56... (1500) | 30... (1500) | 31... (1500) | 272 |
| 0.0033 | 4.6 x 14.6 x 12.5 | 0.44 | 28... (2000) | 29... (2000) | 55... (1500) | 56... (1500) | 30... (1300) | 31... (1300) | 332 |
| 0.0039 | 4.0 x 14.0 x 12.5 | 0.37 | 28... (2000) | 29... (2000) | 55... (1500) | 56... (1500) | 30... (1500) | 31... (1500) | 393 |
| 0.0047 | 4.1 x 14.2 x 12.5 | 0.38 | 28... (2000) | 29... (2000) | 55... (1500) | 56... (1500) | 30... (1500) | 31... (1500) | 472 |
| 0.0056 | 4.6 x 14.6 x 12.5 | 0.44 | 28... (2000) | 29... (2000) | 55... (1500) | 56... (1500) | 30... (1300) | 31... (1300) | 562 |
| 0.0068 | 4.2 x 14.2 x 12.5 | 0.39 | 28... (2000) | 29... (2000) | 55... (1500) | 56... (1500) | 30... (1500) | 31... (1500) | 682 |
| 0.0082 | 4.6 x 14.6 x 12.5 | 0.44 | 28... (2000) | 29... (2000) | 55... (1500) | 56... (1500) | 30... (1300) | 31... (1300) | 822 |
| 0.01 | 4.1 x 14.1 x 12.5 | 0.38 | 28... (2000) | 29... (2000) | 55... (1500) | 56... (1500) | 30... (1500) | 31... (1500) | 103 |
| 0.012 | 4.5 x 14.5 x 12.5 | 0.43 | 28... (2000) | 29... (2000) | 55... (1500) | 56... (1500) | 30... (1300) | 31... (1300) | 123 |
| 0.015 | 4.1 x 14.1 x 12.5 | 0.38 | 28... (2000) | 29... (2000) | 55... (1500) | 56... (1500) | 30... (1500) | 31... (1500) | 153 |
| 0.018 | 4.5 x 14.5 x 12.5 | 0.43 | 28... (2000) | 29... (2000) | 55... (1500) | 56... (1500) | 30... (1300) | 31... (1300) | 183 |
| 0.022 | 4.0 x 14.0 x 12.5 | 0.37 | 28... (2000) | 29... (2000) | 55... (1500) | 56... (1500) | 30... (1500) | 31... (1500) | 223 |
| 0.027 | 4.2 x 14.2 x 12.5 | 0.39 | 28... (2000) | 29... (2000) | 55... (1500) | 56... (1500) | 30... (1500) | 31... (1500) | 273 |
| 0.033 | 4.6 x 14.7 x 12.5 | 0.44 | 28... (2000) | 29... (2000) | 55... (1500) | 56... (1500) | 30... (1300) | 31... (1300) | 333 |
| 0.039 | 5.0 x 14.9 x 12.5 | 0.50 | 28... (1500) | 29... (1500) | 55... (1250) | 56... (1250) | 30... (1200) | 31... (1200) | 393 |
| 0.047 | 4.1 x 14.1 x 12.5 | 0.38 | 28... (2000) | 29... (2000) | 55... (1500) | 56... (1500) | 30... (1500) | 31... (1500) | 473 |
| 0.056 | 4.4 x 14.4 x 12.5 | 0.41 | 28... (2000) | 29... (2000) | 55... (1500) | 56... (1500) | 30... (1500) | 31... (1500) | 563 |
| 0.068 | 4.8 x 14.8 x 12.5 | 0.48 | 28... (2000) | 29... (2000) | 55... (1250) | 56... (1250) | 30... (1300) | 31... (1300) | 683 |
| 0.082 | 5.4 x 15.3 x 12.5 | 0.57 | 28... (1500) | 29... (1500) | 55... (1000) | 56... (1000) | 30... (1200) | 31... (1200) | 823 |
| 0.1 | 5.7 x 15.7 x 12.5 | 0.64 | 28... (1500) | 29... (1500) | 55... (1000) | 56... (1000) | 30... (1100) | 31... (1100) | 104 |

Note

⁽¹⁾ Net weight for short lead product only



$U_{Rdc} = 630\text{ V}$; $U_{Rac} = 250\text{ V}$

| C (μF) | DIMENSIONS $w_{max.} \times h_{max.} \times l_{max.}$ (mm) | MASS (g) ⁽¹⁾ | CATALOG NUMBER BFC2 467..... AND PACKAGING | | | | | | | C-VALUE |
|--|--|----------------------------|--|-----------------------|--------------------------------|-----------------------|---|-----------------------|-------|---------|
| | | | LOOSE IN BOX | | | | REEL | | | |
| | | | $l_t = 3.5 + 1.0/- 0.5\text{ mm}$ | | $l_t = 19.0 \pm 4.0\text{ mm}$ | | $H = 16.0\text{ mm};$ $P_0 = 12.7\text{ mm}$ | | | |
| | | | C-tol. = $\pm 10\%$ | C-tol. = $\pm 5\%$ | C-tol. = $\pm 10\%$ | C-tol. = $\pm 5\%$ | C-tol. = $\pm 10\%$ | C-tol. = $\pm 5\%$ | | |
| | | | XX (SPQ) | XX (SPQ) | XX (SPQ) | XX (SPQ) | XX (SPQ) | XX (SPQ) | ..YYY | |
| Pitch = $10.0 \pm 0.4\text{ mm}$; $d_t = 0.60 \pm 0.06\text{ mm}$ | | | | | | | | | | |
| 0.01 | 4.1 x 14.1 x 12.5 | 0.38 | 40... (2000) | 41... (2000) | 57... (1500) | 58... (1500) | 42... (1500) | 43... (1500) | 103 | |
| 0.012 | 4.5 x 14.5 x 12.5 | 0.43 | 40... (2000) | 41... (2000) | 57... (1500) | 58... (1500) | 42... (1300) | 43... (1300) | 123 | |
| 0.015 | 4.9 x 14.9 x 12.5 | 0.49 | 40... (2000) | 41... (2000) | 57... (1250) | 58... (1250) | 42... (1200) | 43... (1200) | 153 | |
| 0.018 | 5.4 x 15.4 x 12.5 | 0.57 | 40... (1500) | 41... (1500) | 57... (1000) | 58... (1000) | 42... (1100) | 43... (1100) | 183 | |
| 0.022 | 4.8 x 14.8 x 12.5 | 0.48 | 40... (2000) | 41... (2000) | 57... (1250) | 58... (1250) | 42... (1300) | 43... (1300) | 223 | |
| 0.027 | 5.3 x 15.3 x 12.5 | 0.55 | 40... (2000) | 41... (2000) | 57... (1000) | 58... (1000) | 42... (1200) | 43... (1200) | 273 | |
| 0.033 | 5.9 x 15.9 x 12.5 | 0.70 | 40... (1500) | 41... (1500) | 57... (1000) | 58... (1000) | 42... (1100) | 43... (1100) | 333 | |

Note

⁽¹⁾ Net weight for short lead product only



COMPOSITION OF CATALOG NUMBER: 468

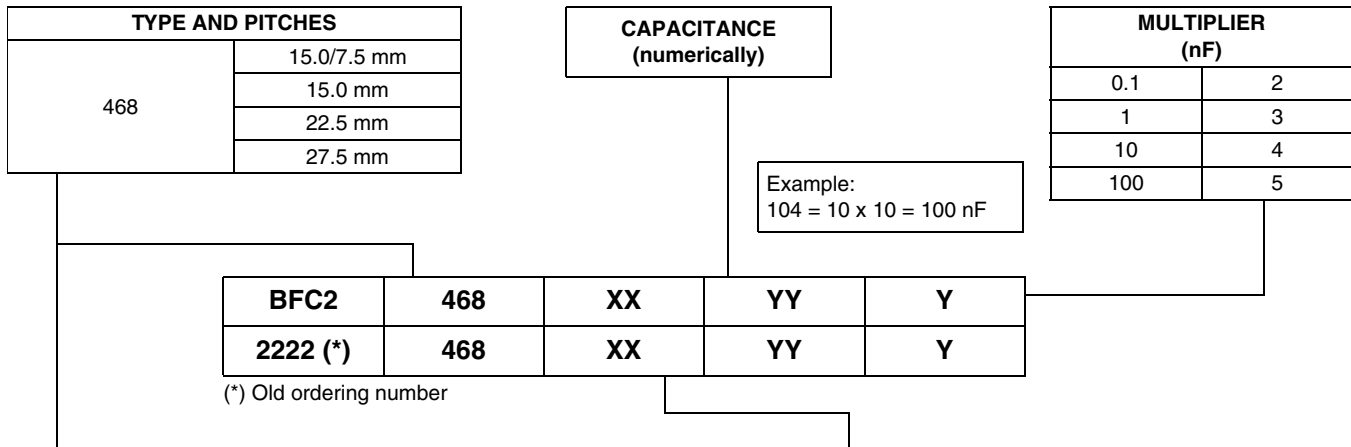

| TYPE | PACKAGING | LEAD CONFIGURATION | PREFERRED TYPES | | | | |
|---------|---|--|--|-------|-------|-------|-------|
| | | | C-TOL. | 100 V | 250 V | 400 V | 630 V |
| MKT 468 | Loose in box | Lead length 3.5 + 1.0/- 0.5 mm (Pitch 10 and 15 mm) | ± 10 % | 04 | 16 | 28 | 40 |
| | | Lead length 3.5 ± 0.5 mm (Pitch 22.5 and 27.5 mm) | ± 5 % | 05 | 17 | 29 | 41 |
| | | Long leads: 19.0 ± 4.0 mm for lead pitch = 15.0 mm | ± 10 % | 51 | 53 | 55 | 57 |
| | | 25.0 ± 4.0 mm for lead pitch = 22.5 mm | ± 5 % | 52 | 54 | 56 | 58 |
| | | 24.0 ± 4.0 mm for lead pitch = 27.5 mm | ± 10 % | 61 | 63 | 65 | 67 |
| | | | ± 5 % | 62 | 64 | 66 | 68 |
| | Taped on reel ⁽¹⁾ (bent back) | H = 16.0 mm; P ₀ = 15.0 mm Reel diameter = 500 mm ⁽²⁾ | Dimensions of these code numbers stay between brackets | | | | |
| | Taped on reel ⁽¹⁾ | H = 16.0 mm; P ₀ = 12.7 mm Reel diameter = 500 mm | ± 10 % | 06 | 18 | 30 | 42 |
| | | | 5 % | 07 | 19 | 31 | 43 |

Notes

- ⁽¹⁾ For detailed tape specifications refer to packaging information: www.vishay.com/docs/28139/packinfo.pdf or end of catalogue
⁽²⁾ Small reel diameter = 356 mm is available on request

SPECIFIC REFERENCE DATA: 468

| DESCRIPTION | VALUE | | | |
|---|-------------------------|--------------------------|--------------------------|---------------|
| | at 1 kHz | at 10 kHz | at 100 kHz | |
| Tangent of loss angle: | | | | |
| C ≤ 0.1 μF | ≤ 75 x 10 ⁻⁴ | ≤ 120 x 10 ⁻⁴ | ≤ 200 x 10 ⁻⁴ | |
| 0.1 μF < C ≤ 0.47 μF | ≤ 75 x 10 ⁻⁴ | ≤ 120 x 10 ⁻⁴ | ≤ 225 x 10 ⁻⁴ | |
| 0.47 μF < C ≤ 10 μF | ≤ 75 x 10 ⁻⁴ | ≤ 150 x 10 ⁻⁴ | - | |
| Rated voltage pulse slope (dU/dt) _R at | 100 Vdc | 250 Vdc | 400 Vdc | 630 Vdc |
| I _{max.} = 12.5 mm | 30 V/μs | 120 V/μs | 170 V/μs | 120 V/μs |
| I _{max.} = 17.5 mm | 20 V/μs | 45 V/μs | 65 V/μs | 90 V/μs |
| I _{max.} = 26.0 mm | 10 V/μs | 20 V/μs | 30 V/μs | 35 V/μs |
| I _{max.} = 30.0 mm | | 15 V/μs | 25 V/μs | 30 V/μs |
| R between leads, for C ≤ 0.33 μF at 100 V; 1 min at 500 V; 1 min | > 15 000 MΩ | > 30 000 MΩ | > 30 000 MΩ | > 30 000 MΩ |
| R between leads, for C > 0.33 μF at 100 V; 1 min at 500 V; 1 min | > 5000 s | > 10 000 s | > 10 000 s | > 10 000 s |
| R between interconnecting leads and casing, at 100 V; 1 min at 500 V; 1 min | > 30 000 MΩ | > 30 000 MΩ | > 30 000 MΩ | > 30 000 MΩ |
| Withstanding (DC) voltage (cut off current 10 mA); rise time 100 V/s | 160 V; 1 min | 400 V; 1 min | 640 V; 1 min | 1008 V; 1 min |
| Withstanding (DC) voltage between leads and case | 200 V; 1 min | 500 V; 1 min | 800 V; 1 min | 1260 V; 1 min |
| Maximum application temperature | 105 °C | | | |



DC Film Capacitor
MKT Radial Lacquered Type

Vishay BCcomponents

$U_{Rdc} = 100\text{ V}$; $U_{Rac} = 63\text{ V}$

| C (μF) | DIMENSIONS $w_{max.} \times h (h')_{max.} \times l_{max.}$ (mm) | MASS (g) ⁽¹⁾ | CATALOG NUMBER BFC2 467..... AND PACKAGING | | | | | | | | | |
|---|---|----------------------------|--|-----------------------|-------------------------|-----------------------|--------------------------------|-----------------------|-------------------------------|-----------------------|---------|--|
| | | | LOOSE IN BOX | | | | REEL H = 16.0 mm | | | | C-VALUE | |
| | | | Original pitch | | Bent back pitch | | Original pitch | | Bent back pitch | | | |
| | | | C-tol. = $\pm 10\%$ | C-tol. = $\pm 5\%$ | C-tol. = $\pm 10\%$ | C-tol. = $\pm 5\%$ | C-tol. = $\pm 10\%$ | C-tol. = $\pm 5\%$ | C-tol. = $\pm 10\%$ | C-tol. = $\pm 5\%$ | ..YYY | |
| XX (SPQ) | XX (SPQ) | XX (SPQ) | XX (SPQ) | XX (SPQ) | XX (SPQ) | XX (SPQ) | XX (SPQ) | XX (SPQ) | XX (SPQ) | | | |
| Pitch = 15.0 \pm 0.4 mm; $d_t = 0.80 \pm 0.08$ mm | | | | | | | | | | | | |
| | | | $l_t = 3.5 + 1.0/- 0.5$ mm | | $l_t = 19.0 \pm 4.0$ mm | | P = 15 mm $P_0 = 12.7$ mm | | P = 7.5 mm $P_0 = 15.0$ mm | | | |
| 1.2 | 5.5 x 14.5 (16.0) x 17.5 | 0.90 | 04... (2000) | 05... (2000) | 51... (1250) | 52... (1250) | 06... (1100) | 07... (1100) | 61... (900) | 62... (900) | 125 | |
| 1.5 | 6.0 x 15.0 (16.5) x 17.5 | 1.00 | 04... (2000) | 05... (2000) | 51... (1250) | 52... (1250) | 06... (1000) | 07... (1000) | 61... (800) | 62... (800) | 155 | |
| 1.8 | 6.5 x 15.5 (17.0) x 17.5 | 1.15 | 04... (1500) | 05... (1500) | 51... (1000) | 52... (1000) | 06... (900) | 07... (900) | 61... (750) | 62... (750) | 185 | |
| 2.2 | 7.0 x 16.0 (17.5) x 17.5 | 1.25 | 04... (1250) | 05... (1250) | 51... (1000) | 52... (1000) | 06... (800) | 07... (800) | 61... (700) | 62... (700) | 225 | |
| 2.7 | 8.0 x 17.0 (18.5) x 17.5 | 1.50 | 04... (1000) | 05... (1000) | 51... (1000) | 52... (1000) | 06... (750) | 07... (750) | 61... (600) | 62... (600) | 275 | |
| 3.3 | 8.5 x 17.5 (19.0) x 17.5 | 1.70 | 04... (1000) | 05... (1000) | 51... (1000) | 52... (1000) | 06... (700) | 07... (700) | 61... (550) | 62... (550) | 335 | |
| Pitch = 22.5 \pm 0.4 mm; $d_t = 0.80 \pm 0.08$ mm | | | | | | | | | | | | |
| | | | $l_t = 3.5 \pm 0.5$ mm | | $l_t = 25.0 \pm 4.0$ mm | | P = 22.5 mm $P_0 = 12.7$ mm | | P = 7.5 mm $P_0 = 15.0$ mm | | | |
| 3.9 | 6.5 x 18.5 x 26.0 | 2.1 | 04... (1000) | 05... (1000) | 51... (750) | 52... (750) | 06... (650) | 07... (650) | | | 395 | |
| 4.7 | 7.0 x 19.5 x 26.0 | 2.3 | 04... (900) | 05... (900) | 51... (700) | 52... (700) | 06... (550) | 07... (550) | | | 475 | |
| 5.6 | 7.5 x 20.0 x 26.0 | 2.5 | 04... (750) | 05... (750) | 51... (600) | 52... (600) | 06... (500) | 07... (500) | | | 565 | |
| 6.8 | 8.5 x 21.5 x 26.0 | 3.2 | 04... (750) | 05... (750) | 51... (500) | 52... (500) | 06... (450) | 07... (450) | | | 685 | |
| 8.2 | 9.5 x 22.5 x 26.0 | 3.4 | 04... (700) | 05... (700) | 51... (500) | 52... (500) | 06... (400) | 07... (400) | | | 825 | |
| 10.0 | 10.5 x 23.5 x 26.0 | 3.8 | 04... (500) | 05... (500) | 51... (400) | 52... (400) | 06... (350) | 07... (350) | | | 106 | |

Note

⁽¹⁾ Net weight for short lead product only

$U_{Rdc} = 250\text{ V}$; $U_{Rac} = 160\text{ V}$

| C (μF) | DIMENSIONS $W_{max.} \times h (h')_{max.} \times l_{max.}$ (mm) | MASS (g) ⁽¹⁾ | CATALOG NUMBER BFC2 468..... AND PACKAGING | | | | | | | | C-VALUE ..YYY |
|--|---|----------------------------|--|-----------------|-------------------------|-----------------|--------------------------------|-----------------|-------------------------------|-----------------|----------------------|
| | | | LOOSE IN BOX | | | | REEL H = 16.0 mm | | | | |
| | | | C-tol. = $\pm 10\%$ | | C-tol. = $\pm 5\%$ | | Original pitch | | Bent back pitch | | |
| | | | XX (SPQ) | XX (SPQ) | XX (SPQ) | XX (SPQ) | XX (SPQ) | XX (SPQ) | XX (SPQ) | XX (SPQ) | |
| Pitch = 15.0 \pm 0.4 mm; $d_t = 0.80 \pm 0.08$ mm | | | | | | | | | | | |
| | | | $l_t = 3.5 + 1.0/- 0.5$ mm | | $l_t = 19.0 \pm 4.0$ mm | | P = 15 mm $P_0 = 12.7$ mm | | P = 7.5 mm $P_0 = 15.0$ mm | | |
| 0.27 | 5.0 x 14.0 (15.5) x 17.5 | 0.80 | 16... (2000) | 17... (2000) | 53... (1250) | 54... (1250) | 18... (1200) | 19... (1200) | 63... (1000) | 64... (1000) | 274 |
| 0.33 | 5.5 x 14.5 (16.0) x 17.5 | 0.90 | 16... (2000) | 17... (2000) | 53... (1250) | 54... (1250) | 18... (1100) | 19... (1100) | 63... (900) | 64... (900) | 334 |
| 0.39 | 6.0 x 15.0 (16.5) x 17.5 | 1.00 | 16... (2000) | 17... (2000) | 53... (1250) | 54... (1250) | 18... (1000) | 19... (1000) | 63... (800) | 64... (800) | 394 |
| 0.47 | 6.5 x 15.5 (17.0) x 17.5 | 1.15 | 16... (1500) | 17... (1500) | 53... (1000) | 54... (1000) | 18... (900) | 19... (900) | 63... (750) | 64... (750) | 474 |
| 0.56 | 7.5 x 16.5 (18.0) x 17.5 | 1.30 | 16... (1250) | 17... (1250) | 53... (1000) | 54... (1000) | 18... (800) | 19... (800) | 63... (650) | 64... (650) | 564 |
| 0.68 | 8.0 x 17.0 (18.5) x 17.5 | 1.50 | 16... (1000) | 17... (1000) | 53... (1000) | 54... (1000) | 18... (750) | 19... (750) | 63... (600) | 64... (600) | 684 |
| 0.82 | 8.5 x 17.5 (19.0) x 17.5 | 1.70 | 16... (1000) | 17... (1000) | 53... (1000) | 54... (1000) | 18... (700) | 19... (700) | 63... (550) | 64... (550) | 824 |
| 1.0 | 8.0 x 20.0 (21.5) x 17.5 | 2.10 | 16... (1000) | 17... (1000) | 53... (900) | 54... (900) | 18... (750) | 19... (750) | 63... (600) | 64... (600) | 105 |
| Pitch = 22.5 \pm 0.4 mm; $d_t = 0.80 \pm 0.08$ mm | | | | | | | | | | | |
| | | | $l_t = 3.5 \pm 0.5$ mm | | $l_t = 25.0 \pm 4.0$ mm | | P = 22.5 mm $P_0 = 12.7$ mm | | P = 7.5 mm $P_0 = 15.0$ mm | | |
| 1.2 | 7.0 x 19.0 x 26.0 | 2.3 | 16... (1000) | 17... (1000) | 53... (700) | 54... (700) | 18... (550) | 19... (550) | | | 125 |
| 1.5 | 8.0 x 21.0 x 26.0 | 2.8 | 16... (750) | 17... (750) | 53... (500) | 54... (500) | 18... (500) | 19... (500) | | | 155 |
| 1.8 | 9.0 x 22.0 x 26.0 | 3.3 | 16... (750) | 17... (750) | 53... (500) | 54... (500) | 18... (450) | 19... (450) | | | 185 |
| 2.2 | 9.8 x 23.0 x 26.0 | 3.4 | 16... (750) | 17... (750) | 53... (450) | 54... (450) | 18... (400) | 19... (400) | | | 225 |
| 2.7 | 11.0 x 24.0 x 26.0 | 4.0 | 16... (500) | 17... (500) | 53... (400) | 54... (400) | 18... (350) | 19... (350) | | | 275 |
| 3.3 | 12.5 x 25.5 x 26.0 | 4.5 | 16... (500) | 17... (500) | 53... (300) | 54... (300) | 18... (350) | 19... (350) | | | 335 |
| 3.9 | 13.5 x 26.5 x 26.0 | 5.5 | 16... (400) | 17... (400) | 53... (300) | 54... (300) | 18... (300) | 19... (300) | | | 395 |
| 4.7 | 14.9 x 28.0 x 26.0 | 6.3 | 16... (250) | 17... (250) | 53... (250) | 54... (250) | 18... (250) | 19... (250) | | | 475 |
| Pitch = 27.5 \pm 0.4 mm; $d_t = 0.80 \pm 0.08$ mm; A = 2.5 + 1.4/- 0.5 mm | | | | | | | | | | | |
| | | | $l_t = 3.5 \pm 0.5$ mm | | $l_t = 24.0 \pm 4.0$ mm | | P = 27.5 mm $P_0 = 12.7$ mm | | P = 7.5 mm $P_0 = 15.0$ mm | | |
| 5.6 | 15.0 x 28.0 x 30.0 | 7.5 | 16... (300) | 17... (300) | 53... (200) | 54... (200) | - | - | | | 565 |

Note

⁽¹⁾ Net weight for short lead product only



DC Film Capacitor
MKT Radial Lacquered Type

Vishay BCcomponents

$U_{Rdc} = 400\text{ V}$; $U_{Rac} = 220\text{ V}$

| C (μF) | DIMENSIONS $W_{max.} \times h (h')_{max.} \times l_{max.}$ (mm) | MASS (g) ⁽¹⁾ | CATALOG NUMBER BFC2 468..... AND PACKAGING | | | | | | | | | |
|--|---|----------------------------|--|-----------------|-------------------------|-----------------|--------------------------------|-----------------|-------------------------------|-----------------|---------|--|
| | | | LOOSE IN BOX | | | | REEL H = 16.0 mm | | | | C-VALUE | |
| | | | C-tol. = $\pm 10\%$ | | C-tol. = $\pm 5\%$ | | Original pitch | | Bent back pitch | | | |
| | | | XX (SPQ) | XX (SPQ) | XX (SPQ) | XX (SPQ) | XX (SPQ) | XX (SPQ) | XX (SPQ) | XX (SPQ) | ..YYY | |
| Pitch = 15.0 \pm 0.4 mm; $d_t = 0.80 \pm 0.08$ mm | | | | | | | | | | | | |
| | | | $l_t = 3.5 + 1.0/- 0.5$ mm | | $l_t = 19.0 \pm 4.0$ mm | | P = 15 mm $P_0 = 12.7$ mm | | P = 7.5 mm $P_0 = 15.0$ mm | | | |
| 0.12 | 5.0 x 14.0 (15.5) x 17.5 | 0.80 | 28... (2000) | 29... (2000) | 55... (1250) | 56... (1250) | 30... (1200) | 31... (1200) | 65... (1000) | 66... (1000) | 124 | |
| 0.15 | 5.8 x 15.0 (16.5) x 17.5 | 0.95 | 28... (1750) | 29... (1750) | 55... (1250) | 56... (1250) | 30... (1100) | 31... (1100) | 65... (850) | 66... (850) | 154 | |
| 0.18 | 6.5 x 15.5 (17.0) x 17.5 | 1.15 | 28... (1500) | 29... (1500) | 55... (1000) | 56... (1000) | 30... (900) | 31... (900) | 65... (750) | 66... (750) | 184 | |
| 0.22 | 7.0 x 16.0 (17.5) x 17.5 | 1.25 | 28... (1500) | 29... (1500) | 55... (1000) | 56... (1000) | 30... (800) | 31... (800) | 65... (700) | 66... (700) | 224 | |
| 0.27 | 7.4 x 16.5 (18.0) x 17.5 | 1.28 | 28... (1250) | 29... (1250) | 55... (1250) | 56... (1250) | 30... (800) | 31... (800) | 65... (650) | 66... (650) | 274 | |
| 0.33 | 8.5 x 17.5 (19.0) x 17.5 | 1.70 | 28... (1000) | 29... (1000) | 55... (1000) | 56... (1000) | 30... (700) | 31... (700) | 65... (550) | 66... (550) | 334 | |
| 0.39 | 7.4 x 19.5 (21.0) x 17.5 | 2.00 | 28... (1000) | 29... (1000) | 55... (1000) | 56... (1000) | 30... (800) | 31... (800) | 65... (650) | 66... (650) | 394 | |
| 0.47 | 8.4 x 20.5 (22.0) x 17.5 | 2.10 | 28... (750) | 29... (750) | 55... (850) | 56... (850) | 30... (700) | 31... (700) | 65... (550) | 66... (550) | 474 | |
| Pitch = 22.5 \pm 0.4 mm; $d_t = 0.80 \pm 0.08$ mm | | | | | | | | | | | | |
| | | | $l_t = 3.5 \pm 0.5$ mm | | $l_t = 25.0 \pm 4.0$ mm | | P = 22.5 mm $P_0 = 12.7$ mm | | P = 7.5 mm $P_0 = 15.0$ mm | | | |
| 0.56 | 7.0 x 19.5 x 26.0 | 2.5 | 28... (1000) | 29... (1000) | 55... (650) | 56... (650) | 30... (550) | 28... (550) | | | 564 | |
| 0.68 | 8.0 x 21.0 x 26.0 | 2.8 | 28... (750) | 29... (750) | 55... (500) | 56... (500) | 30... (500) | 28... (500) | | | 684 | |
| 0.82 | 9.0 x 22.0 x 26.0 | 3.3 | 28... (750) | 29... (750) | 55... (500) | 56... (500) | 30... (450) | 28... (450) | | | 824 | |
| 1.0 | 9.9 x 23.0 x 26.0 | 3.5 | 28... (750) | 29... (750) | 55... (450) | 56... (450) | 30... (400) | 28... (400) | | | 105 | |
| 1.2 | 11.0 x 24.0 x 26.0 | 4.0 | 28... (500) | 29... (500) | 55... (400) | 56... (400) | 30... (350) | 28... (350) | | | 125 | |
| Pitch = 27.5 \pm 0.4 mm; $d_t = 0.80 \pm 0.08$ mm; A = 2.5 + 1.4/- 0.5 mm | | | | | | | | | | | | |
| | | | $l_t = 3.5 \pm 0.5$ mm | | $l_t = 24.0 \pm 4.0$ mm | | P = 27.5 mm $P_0 = 12.7$ mm | | P = 7.5 mm $P_0 = 15.0$ mm | | | |
| 1.5 | 11.5 x 24.5 x 30.0 | 5.8 | 28... (450) | 29... (450) | 55... (300) | 56... (300) | | | | | 155 | |
| 1.8 | 12.5 x 25.5 x 30.0 | 6.4 | 28... (350) | 29... (350) | 55... (250) | 56... (250) | | | | | 185 | |
| 2.2 | 14.0 x 27.0 x 30.0 | 7.3 | 28... (300) | 29... (300) | 55... (200) | 56... (200) | | | | | 225 | |

Note

⁽¹⁾ Net weight for short lead product only

$U_{Rdc} = 630 V$; $U_{Rac} = 250 V$

| C (μF) | DIMENSIONS $w_{max.} \times h (h')_{max.} \times l_{max.}$ (mm) | MASS (g) ⁽¹⁾ | CATALOG NUMBER BFC2 468..... AND PACKAGING | | | | | | | | C-VALUE ..YYY |
|--|---|----------------------------|--|-----------------|-------------------------|-----------------|--------------------------------|-----------------|-------------------------------|-----------------|----------------------|
| | | | LOOSE IN BOX | | | | REEL H = 16.0 mm | | | | |
| | | | C-tol. = $\pm 10\%$ | | C-tol. = $\pm 5\%$ | | Original pitch | | Bent back pitch | | |
| | | | XX (SPQ) | XX (SPQ) | XX (SPQ) | XX (SPQ) | XX (SPQ) | XX (SPQ) | XX (SPQ) | XX (SPQ) | |
| Pitch = 15.0 \pm 0.4 mm; $d_t = 0.80 \pm 0.08$ mm | | | | | | | | | | | |
| | | | $l_t = 3.5$ + 1.0/- 0.5 mm | | $l_t = 19.0 \pm 4.0$ mm | | P = 15 mm $P_0 = 12.7$ mm | | P = 7.5 mm $P_0 = 15.0$ mm | | |
| 0.039 | 5.0 x 14.0 (15.5) x 17.5 | 0.80 | 40... (2000) | 41... (2000) | 57... (1250) | 58... (1250) | 42... (1200) | 43... (1200) | 67... (1000) | 68... (1000) | 393 |
| 0.047 | 5.5 x 14.5 (16.0) x 17.5 | 0.90 | 40... (2000) | 41... (2000) | 57... (1250) | 58... (1250) | 42... (1100) | 43... (1100) | 67... (900) | 68... (900) | 473 |
| 0.056 | 5.9 x 15.0 (16.5) x 17.5 | 0.95 | 40... (1750) | 41... (1750) | 57... (1250) | 58... (1250) | 42... (1000) | 43... (1000) | 67... (850) | 68... (850) | 563 |
| 0.068 | 6.5 x 16.0 (17.5) x 17.5 | 1.15 | 40... (1500) | 41... (1500) | 57... (1000) | 58... (1000) | 42... (800) | 43... (800) | 67... (750) | 68... (750) | 683 |
| 0.082 | 7.3 x 16.5 (18.0) x 17.5 | 1.27 | 40... (1500) | 41... (1500) | 57... (1000) | 58... (1000) | 42... (800) | 43... (800) | 67... (650) | 68... (650) | 823 |
| 0.1 | 7.9 x 17.0 (18.5) x 17.5 | 1.48 | 40... (1250) | 41... (1250) | 57... (1000) | 58... (1000) | 42... (750) | 43... (750) | 67... (600) | 68... (600) | 104 |
| 0.12 | 7.5 x 19.5 (21.0) x 17.5 | 2.00 | 40... (1250) | 41... (1250) | 57... (1000) | 58... (1000) | 42... (800) | 43... (800) | 67... (650) | 68... (650) | 124 |
| 0.15 | 8.5 x 20.5 (22.0) x 17.5 | 2.20 | 40... (1000) | 41... (1000) | 57... (850) | 58... (850) | 42... (700) | 43... (700) | 67... (550) | 68... (550) | 154 |
| Pitch = 22.5 \pm 0.4 mm; $d_t = 0.80 \pm 0.08$ mm | | | | | | | | | | | |
| | | | $l_t = 3.5 \pm 0.5$ mm | | $l_t = 25.0 \pm 4.0$ mm | | P = 22.5 mm $P_0 = 12.7$ mm | | P = 7.5 mm $P_0 = 15.0$ mm | | |
| 0.18 | 7.5 x 19.5 x 26.0 | 2.5 | 40... (1000) | 41... (1000) | 57... (650) | 58... (650) | 42... (550) | 43... (550) | | | 184 |
| 0.22 | 8.0 x 21.0 x 26.0 | 2.8 | 40... (750) | 41... (750) | 57... (500) | 58... (500) | 42... (500) | 43... (500) | | | 224 |
| 0.27 | 9.0 x 22.0 x 26.0 | 3.3 | 40... (750) | 41... (750) | 57... (500) | 58... (500) | 42... (450) | 43... (450) | | | 274 |
| 0.33 | 10.0 x 23.0 x 26.0 | 3.5 | 40... (700) | 41... (700) | 57... (450) | 58... (450) | 42... (400) | 43... (400) | | | 334 |
| 0.39 | 11.5 x 24.0 x 26.0 | 4.2 | 40... (600) | 41... (600) | 57... (400) | 58... (400) | 42... (350) | 43... (350) | | | 394 |
| 0.47 | 12.5 x 25.5 x 26.0 | 4.5 | 40... (500) | 41... (500) | 57... (300) | 58... (300) | 42... (350) | 43... (350) | | | 474 |
| 0.56 | 13.5 x 26.6 x 26.0 | 5.5 | 40... (450) | 41... (450) | 57... (300) | 58... (300) | 42... (300) | 43... (300) | | | 564 |
| 0.68 | 15.0 x 28.0 x 26.0 | 6.5 | 40... (400) | 41... (400) | 57... (250) | 58... (250) | 42... (250) | 43... (250) | | | 684 |
| Pitch = 27.5 \pm 0.4 mm; $d_t = 0.80 \pm 0.08$ mm; A = 2.5 + 1.4/- 0.5 mm | | | | | | | | | | | |
| | | | $l_t = 3.5 \pm 0.5$ mm | | $l_t = 24.0 \pm 4.0$ mm | | P = 27.5 mm $P_0 = 12.7$ mm | | P = 7.5 mm $P_0 = 15.0$ mm | | |
| 0.82 | 15.0 x 28.0 x 30.0 | 7.5 | 40... (300) | 41... (300) | 57... (200) | 58... (200) | - | - | | | - |

Note

⁽¹⁾ Net weight for short lead product only



COMPOSITION OF CATALOG NUMBER: 469

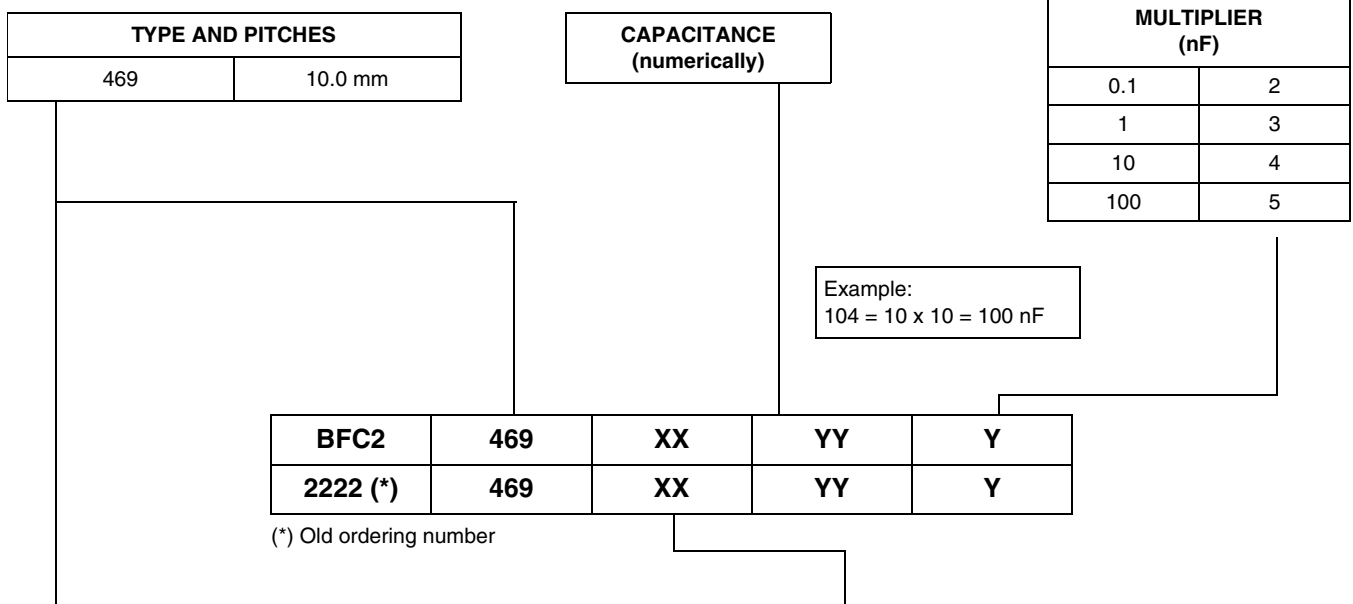

| TYPE | PACKAGING | LEAD CONFIGURATION | PREFERRED TYPES | | | | |
|---------|-------------------|---|-----------------|-------|-------|-------|-------|
| | | | C-TOL. | 100 V | 250 V | 400 V | 630 V |
| MKT 469 | Loose in box | Lead length 4.0 + 1.0/- 0.5 mm | ± 10 % | 25 | 45 | 55 | 65 |
| | | | ± 5 % | 26 | 46 | 56 | 66 |
| | | Lead length 22.0 ± 4.0 mm | ± 10 % | 21 | 41 | 51 | 61 |
| | | | ± 5 % | 22 | 42 | 52 | 62 |
| | Taped on reel (1) | H = 18.5 mm; P ₀ = 12.7 mm Reel diameter = 500 mm | ± 10 % | 28 | 48 | 58 | 68 |
| | | | ± 5 % | 29 | 49 | 59 | 69 |

Notes

- (1) For detailed tape specifications refer to packaging information: www.vishay.com/docs/28139/packinfo.pdf or end of catalogue
- (2) SPQ = Standard Packaging Quantity

SPECIFIC REFERENCE DATA: 469

| DESCRIPTION | VALUE | | | |
|---|-------------------------|--------------------------|--------------------------|---------------|
| | at 1 kHz | at 10 kHz | at 100 kHz | |
| Tangent of loss angle: | | | | |
| C ≤ 0.1 μF | ≤ 75 x 10 ⁻⁴ | ≤ 120 x 10 ⁻⁴ | ≤ 200x 10 ⁻⁴ | |
| 0.1 μF < C ≤ 0.47 μF | ≤ 75 x 10 ⁻⁴ | ≤ 120 x 10 ⁻⁴ | ≤ 225 x 10 ⁻⁴ | |
| 0.47 μF < C ≤ 1.0 μF | ≤ 75 x 10 ⁻⁴ | ≤ 120 x 10 ⁻⁴ | - | |
| Rated voltage pulse slope (dU/dt) _R at I _{max.} = 12.5 mm | 100 Vdc | 250 Vdc | 400 Vdc | 630 Vdc |
| | 30 V/μs | 120 V/μs | 170 V/μs | 120 V/μs |
| R between leads, for C ≤ 0.33 μF at 100 V; 1 min at 500 V; 1 min | > 15 000 MΩ | > 30 000 MΩ | > 30 000 MΩ | > 30 000 MΩ |
| R between leads, for C > 0.33 μF at 100 V; 1 min at 500 V; 1 min | > 5000 s | > 10 000 s | > 10 000 s | > 10 000 s |
| R between interconnecting leads and casing, at 100 V; 1 min at 500 V; 1 min | > 30 000 MΩ | > 30 000 MΩ | > 30 000 MΩ | > 30 000 MΩ |
| Withstanding (DC) voltage (cut off current 10 mA); rise time 100 V/s | 160 V; 1 min | 400 V; 1 min | 640 V; 1 min | 1008 V; 1 min |
| Withstanding (DC) voltage between leads and case | 200 V; 1 min | 500 V; 1 min | 840 V; 1 min | 1260 V; 1 min |
| Maximum application temperature | 105 °C | | | |

$U_{Rdc} = 100\text{ V}$; $U_{Rac} = 63\text{ V}$

| C (μF) | DIMENSIONS $w_{max.} \times h_{max.} \times l_{max.}$ (mm) | MASS (g) ⁽¹⁾ | CATALOG NUMBER BFC2 469..... AND PACKAGING | | | | | | | C-VALUE ..YYY |
|---|--|----------------------------|--|-----------------------|--------------------------------|-----------------------|--|-----------------------|--------------------------|----------------------|
| | | | LOOSE IN BOX | | | | REEL | | C-tol. = $\pm 5\%$ | |
| | | | $l_t = 4.0 + 1.0/- 0.5\text{ mm}$ | | $l_t = 22.0 \pm 4.0\text{ mm}$ | | H = 18.5 mm; P ₀ = 12.7 mm | | | |
| | | | C-tol. = $\pm 10\%$ | C-tol. = $\pm 5\%$ | C-tol. = $\pm 10\%$ | C-tol. = $\pm 5\%$ | C-tol. = $\pm 10\%$ | C-tol. = $\pm 5\%$ | | |
| XX (SPQ) | XX (SPQ) | XX (SPQ) | XX (SPQ) | XX (SPQ) | XX (SPQ) | | | | | |
| Pitch = 10.0 \pm 0.4 mm; $d_t = 0.60 \pm 0.06\text{ mm}$ | | | | | | | | | | |
| 0.056 0.068 0.082 0.1 | 4.0 x 11.0 x 12.5 | 0.35 | 25... (2000) | 26... (2000) | 21... (1500) | 22... (1500) | 28... (1500) | 29... (1500) | 563 683 823 104 | |
| 0.12 | 4.3 x 11.3 x 12.5 | 0.38 | 25... (2000) | 26... (2000) | 21... (1500) | 22... (1500) | 28... (1500) | 29... (1500) | 124 | |
| 0.15 | 3.9 x 10.9 x 12.5 | 0.34 | 25... (2000) | 26... (2000) | 21... (1500) | 22... (1500) | 28... (1500) | 29... (1500) | 154 | |
| 0.18 | 4.2 x 11.2 x 12.5 | 0.37 | 25... (2000) | 26... (2000) | 21... (1500) | 22... (1500) | 28... (1500) | 29... (1500) | 184 | |
| 0.22 | 4.5 x 11.5 x 12.5 | 0.40 | 25... (2000) | 26... (2000) | 21... (1500) | 22... (1500) | 28... (1300) | 29... (1300) | 224 | |
| 0.27 | 4.2 x 11.2 x 12.5 | 0.37 | 25... (2000) | 26... (2000) | 21... (1500) | 22... (1500) | 28... (1500) | 29... (1500) | 274 | |
| 0.33 | 4.6 x 11.6 x 12.5 | 0.41 | 25... (2000) | 26... (2000) | 21... (1500) | 22... (1500) | 28... (1300) | 29... (1300) | 334 | |
| 0.39 | 4.0 x 11.0 x 12.5 | 0.35 | 25... (2000) | 26... (2000) | 21... (1500) | 22... (1500) | 28... (1500) | 29... (1500) | 394 | |
| 0.47 | 4.2 x 11.2 x 12.5 | 0.37 | 25... (2000) | 26... (2000) | 21... (1500) | 22... (1500) | 28... (1500) | 29... (1500) | 474 | |
| 0.56 | 4.6 x 11.6 x 12.5 | 0.41 | 25... (2000) | 26... (2000) | 21... (1500) | 22... (1500) | 28... (1300) | 29... (1300) | 564 | |
| 0.68 | 5.0 x 12.0 x 12.5 | 0.44 | 25... (1500) | 26... (1500) | 21... (1250) | 22... (1250) | 28... (1200) | 29... (1200) | 684 | |
| 0.82 | 5.5 x 12.5 x 12.5 | 0.47 | 25... (1500) | 26... (1500) | 21... (1000) | 22... (1000) | 28... (1100) | 29... (1100) | 824 | |
| 1.0 | 6.0 x 13.0 x 12.5 | 0.55 | 25... (1250) | 26... (1250) | 21... (1000) | 22... (1000) | 28... (1000) | 29... (1000) | 105 | |

Note

⁽¹⁾ Net weight for short lead product only



DC Film Capacitor
MKT Radial Lacquered Type

Vishay BCcomponents

$U_{Rdc} = 250 V$; $U_{Rac} = 160 V$

| C (μF) | DIMENSIONS $w_{max.} \times h_{max.} \times l_{max.}$ (mm) | MASS (g) ⁽¹⁾ | CATALOG NUMBER BFC2 469..... AND PACKAGING | | | | | | | C-VALUE ..YYY |
|--|--|----------------------------|--|-----------------------|-------------------------|-----------------------|--|-----------------------|-----|----------------------|
| | | | LOOSE IN BOX | | | | REEL | | | |
| | | | $l_t = 4.0 + 1.0/- 0.5$ mm | | $l_t = 22.0 \pm 4.0$ mm | | H = 18.5 mm; P ₀ = 12.7 mm | | | |
| | | | C-tol. = ± 10 % | C-tol. = ± 5 % | C-tol. = ± 10 % | C-tol. = ± 5 % | C-tol. = ± 10 % | C-tol. = ± 5 % | | |
| | | | XX (SPQ) | XX (SPQ) | XX (SPQ) | XX (SPQ) | XX (SPQ) | XX (SPQ) | | |
| Pitch = 10.0 \pm 0.4 mm; d _t = 0.60 \pm 0.06 mm | | | | | | | | | | |
| 0.027 | 4.2 x 11.2 x 12.5 | 0.37 | 45... (2000) | 46... (2000) | 41... (1500) | 42... (1500) | 48... (1500) | 49... (1500) | 273 | |
| 0.033 | 4.6 x 11.6 x 12.5 | 0.41 | 45... (2000) | 467... (2000) | 41... (1500) | 42... (1500) | 48... (1300) | 49... (1300) | 333 | |
| 0.039 | 4.0 x 11.0 x 12.5 | 0.35 | 45... (2000) | 46... (2000) | 41... (1500) | 42... (1500) | 48... (1500) | 49... (1500) | 393 | |
| 0.047 | 4.1 x 11.1 x 12.5 | 0.36 | 45... (2000) | 46... (2000) | 41... (1500) | 42... (1500) | 48... (1500) | 49... (1500) | 473 | |
| 0.056 | 4.0 x 11.0 x 12.5 | 0.35 | 45... (2000) | 46... (2000) | 41... (1500) | 42... (1500) | 48... (1500) | 49... (1500) | 563 | |
| 0.068 | 4.1 x 11.1 x 12.5 | 0.36 | 45... (2000) | 46... (2000) | 41... (1500) | 42... (1500) | 48... (1500) | 49... (1500) | 683 | |
| 0.082 | 4.4 x 11.4 x 12.5 | 0.39 | 45... (2000) | 46... (2000) | 41... (1500) | 42... (1500) | 48... (1500) | 49... (1500) | 823 | |
| 0.1 | 4.0 x 11.0 x 12.5 | 0.35 | 45... (2000) | 46... (2000) | 41... (1500) | 42... (1500) | 48... (1500) | 49... (1500) | 104 | |
| 0.12 | 4.3 x 11.3 x 12.5 | 0.38 | 45... (2000) | 46... (2000) | 41... (1500) | 42... (1500) | 48... (1500) | 49... (1500) | 124 | |
| 0.15 | 4.8 x 11.8 x 12.5 | 0.42 | 45... (2000) | 46... (2000) | 41... (1250) | 42... (1250) | 48... (1300) | 49... (1300) | 154 | |
| 0.18 | 5.2 x 12.2 x 12.5 | 0.45 | 45... (1500) | 46... (1500) | 41... (1000) | 42... (1000) | 48... (1200) | 49... (1200) | 184 | |
| 0.22 | 5.8 x 12.8 x 12.5 | 0.50 | 45... (1500) | 46... (1500) | 41... (1000) | 42... (1000) | 48... (1100) | 49... (1100) | 224 | |

Note

⁽¹⁾ Net weight for short lead product only

$U_{Rdc} = 400\text{ V}$; $U_{Rac} = 220\text{ V}$

| C (μF) | DIMENSIONS $w_{max.} \times h_{max.} \times l_{max.}$ (mm) | MASS (g) ⁽¹⁾ | CATALOG NUMBER BFC2 469..... AND PACKAGING | | | | | | C-VALUE ..YYY |
|--|--|----------------------------|--|-----------------------|--------------------------------|-----------------------|--|-----------------------|----------------------|
| | | | LOOSE IN BOX | | | | REEL | | |
| | | | $l_t = 4.0 + 1.0/- 0.5\text{ mm}$ | | $l_t = 22.0 \pm 4.0\text{ mm}$ | | H = 18.5 mm; P ₀ = 12.7 mm | | |
| | | | C-tol. = $\pm 10\%$ | C-tol. = $\pm 5\%$ | C-tol. = $\pm 10\%$ | C-tol. = $\pm 5\%$ | C-tol. = $\pm 10\%$ | C-tol. = $\pm 5\%$ | |
| XX (SPQ) | XX (SPQ) | XX (SPQ) | XX (SPQ) | XX (SPQ) | XX (SPQ) | XX (SPQ) | XX (SPQ) | XX (SPQ) | |
| Pitch = 10.0 ± 0.4 mm; d_t = 0.60 ± 0.06 mm | | | | | | | | | |
| 0.001 | 4.5 x 11.5 x 12.5 | 0.40 | 55... | 56... | 51... | 52... | 58... | 59... | 102 |
| 0.0012 | | | (2000) | (2000) | (1500) | (1500) | (1300) | (1300) | 122 |
| 0.0015 | | | | | | | | | 152 |
| 0.0018 | | | | | | | | | 182 |
| 0.0022 | 4.0 x 11.0 x 12.5 | 0.35 | 55... (2000) | 56... (2000) | 51... (1500) | 52... (1500) | 58... (1500) | 59... (1500) | 222 |
| 0.0027 | 4.3 x 11.3 x 12.5 | 0.38 | 55... (2000) | 56... (2000) | 51... (1500) | 52... (1500) | 58... (1500) | 59... (1500) | 272 |
| 0.0033 | 4.6 x 11.6 x 12.5 | 0.41 | 55... (2000) | 56... (2000) | 51... (1500) | 52... (1500) | 58... (1300) | 59... (1300) | 332 |
| 0.0039 | 4.0 x 11.0 x 12.5 | 0.35 | 55... (2000) | 56... (2000) | 51... (1500) | 52... (1500) | 58... (1500) | 59... (1500) | 392 |
| 0.0047 | 4.1 x 11.1 x 12.5 | 0.36 | 55... (2000) | 56... (2000) | 51... (1500) | 52... (1500) | 58... (1500) | 59... (1500) | 472 |
| 0.0056 | 4.6 x 11.6 x 12.5 | 0.41 | 55... (2000) | 56... (2000) | 51... (1500) | 52... (1500) | 58... (1300) | 59... (1300) | 562 |
| 0.0068 | 4.2 x 11.2 x 12.5 | 0.37 | 55... (2000) | 56... (2000) | 51... (1500) | 52... (1500) | 58... (1500) | 59... (1500) | 682 |
| 0.0082 | 4.6 x 11.6 x 12.5 | 0.41 | 55... (2000) | 56... (2000) | 51... (1500) | 52... (1500) | 58... (1300) | 59... (1300) | 822 |
| 0.01 | 4.1 x 11.1 x 12.5 | 0.36 | 55... (2000) | 56... (2000) | 51... (1500) | 52... (1500) | 58... (1500) | 59... (1500) | 103 |
| 0.012 | 4.5 x 11.5 x 12.5 | 0.40 | 55... (2000) | 56... (2000) | 51... (1500) | 52... (1500) | 58... (1300) | 59... (1300) | 123 |
| 0.015 | 4.1 x 11.1 x 12.5 | 0.36 | 55... (2000) | 56... (2000) | 51... (1500) | 52... (1500) | 58... (1500) | 59... (1500) | 153 |
| 0.018 | 4.5 x 11.5 x 12.5 | 0.40 | 55... (2000) | 56... (2000) | 51... (1500) | 52... (1500) | 58... (1300) | 59... (1300) | 183 |
| 0.022 | 4.0 x 11.0 x 12.5 | 0.35 | 55... (2000) | 56... (2000) | 51... (1500) | 52... (1500) | 58... (1500) | 59... (1500) | 223 |
| 0.027 | 4.2 x 11.2 x 12.5 | 0.37 | 55... (2000) | 56... (2000) | 51... (1500) | 52... (1500) | 58... (1500) | 59... (1500) | 273 |
| 0.033 | 4.6 x 11.6 x 12.5 | 0.41 | 55... (2000) | 56... (2000) | 51... (1500) | 52... (1500) | 58... (1300) | 59... (1300) | 333 |
| 0.039 | 5.0 x 12.0 x 12.5 | 0.44 | 55... (1500) | 56... (1500) | 51... (1250) | 52... (1250) | 58... (1200) | 59... (1200) | 393 |
| 0.047 | 4.1 x 11.1 x 12.5 | 0.36 | 55... (2000) | 56... (2000) | 51... (1500) | 52... (1500) | 58... (1500) | 59... (1500) | 473 |
| 0.056 | 4.4 x 11.4 x 12.5 | 0.39 | 55... (2000) | 56... (2000) | 51... (1500) | 52... (1500) | 58... (1500) | 59... (1500) | 563 |
| 0.068 | 4.8 x 11.8 x 12.5 | 0.42 | 55... (2000) | 56... (2000) | 51... (1250) | 52... (1250) | 58... (1300) | 59... (1300) | 683 |
| 0.082 | 5.4 x 12.4 x 12.5 | 0.46 | 55... (1500) | 56... (1500) | 51... (1000) | 52... (1000) | 58... (1200) | 59... (1200) | 823 |
| 0.1 | 5.7 x 12.7 x 12.5 | 0.48 | 55... (1500) | 56... (1500) | 51... (1000) | 52... (1000) | 58... (1100) | 59... (1100) | 104 |

Note

⁽¹⁾ Net weight for short lead product only



$U_{Rdc} = 630\text{ V}$; $U_{Rac} = 250\text{ V}$

| C (μF) | DIMENSIONS $w_{max.} \times h_{max.} \times l_{max.}$ (mm) | MASS (g) ⁽¹⁾ | CATALOG NUMBER BFC2 469..... AND PACKAGING | | | | | | |
|--|--|----------------------------|--|-----------------------|--------------------------------|-----------------------|--|-----------------------|---------|
| | | | LOOSE IN BOX | | | | REEL | | C-VALUE |
| | | | $l_t = 4.0 + 1.0/- 0.5\text{ mm}$ | | $l_t = 22.0 \pm 4.0\text{ mm}$ | | H = 18.5 mm; P ₀ = 12.7 mm | | |
| | | | C-tol. = $\pm 10\%$ | C-tol. = $\pm 5\%$ | C-tol. = $\pm 10\%$ | C-tol. = $\pm 5\%$ | C-tol. = $\pm 10\%$ | C-tol. = $\pm 5\%$ | |
| | | | XX (SPQ) | XX (SPQ) | XX (SPQ) | XX (SPQ) | XX (SPQ) | XX (SPQ) | ..YYY |
| Pitch = 10.0 \pm 0.4 mm; d _t = 0.60 \pm 0.06 mm | | | | | | | | | |
| 0.01 | 4.1 x 11.1 x 12.5 | 0.36 | 65... (2000) | 66... (2000) | 61... (1500) | 62... (1500) | 68... (1500) | 69... (1500) | 103 |
| 0.012 | 4.5 x 11.5 x 12.5 | 0.40 | 65... (2000) | 66... (2000) | 61... (1500) | 62... (1500) | 68... (1300) | 69... (1300) | 123 |
| 0.015 | 4.9 x 11.9 x 12.5 | 0.43 | 65... (2000) | 66... (2000) | 61... (1250) | 62... (1250) | 68... (1200) | 69... (1200) | 153 |
| 0.018 | 5.4 x 12.4 x 12.5 | 0.46 | 65... (1500) | 66... (1500) | 61... (1000) | 62... (1000) | 68... (1100) | 69... (1100) | 183 |
| 0.022 | 4.8 x 11.8 x 12.5 | 0.42 | 65... (2000) | 66... (2000) | 61... (1250) | 62... (1250) | 68... (1300) | 69... (1300) | 223 |
| 0.027 | 5.3 x 12.3 x 12.5 | 0.46 | 65... (2000) | 66... (2000) | 61... (1000) | 62... (1000) | 68... (1200) | 69... (1200) | 273 |
| 0.033 | 5.9 x 12.9 x 12.5 | 0.52 | 65... (1500) | 66... (1500) | 61... (1000) | 62... (1000) | 68... (1100) | 69... (1100) | 333 |

Note

⁽¹⁾ Net weight for short lead product only

MOUNTING

Normal Use

The capacitors are designed for mounting on printed-circuit boards. The capacitors packed in bandoliers are designed for mounting in printed-circuit boards by means of automatic insertion machines.

For detailed tape specifications refer to packaging information: www.vishay.com/docs/28139/packinfo.pdf or end of catalogue.

Specific Method of Mounting to Withstand Vibration and Shock

In order to withstand vibration and shock tests, it must be ensured that the underside and the kinks are in good contact with the printed-circuit board.

- For pitches $\leq 15\text{ mm}$ capacitors shall be mechanically fixed by the leads
- For larger pitches the capacitors shall be mounted in the same way and the body clamped

Storage Temperature

- Storage temperature: $T_{stg} = -25\text{ }^\circ\text{C}$ to $+40\text{ }^\circ\text{C}$ with RH maximum 80 % without condensation

Ratings and Characteristics Reference Conditions

Unless otherwise specified, all electrical values apply to an ambient free air temperature of $23 \pm 1\text{ }^\circ\text{C}$, an atmospheric pressure of 86 kPa to 106 kPa and a relative humidity of $50 \pm 2\%$.

For reference testing, a conditioning period shall be applied over $96 \pm 4\text{ h}$ by heating the products in a circulating air oven at the rated temperature and a relative humidity not exceeding 20 %.

CHARACTERISTICS

Capacitance as a function of frequency (typical curve)

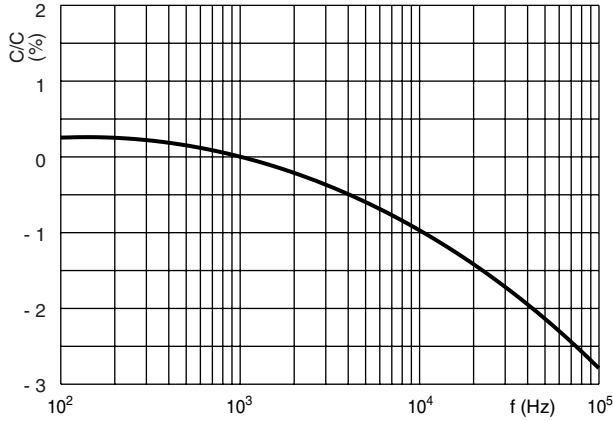

Capacitance as a function of ambient temperature (typical curve)

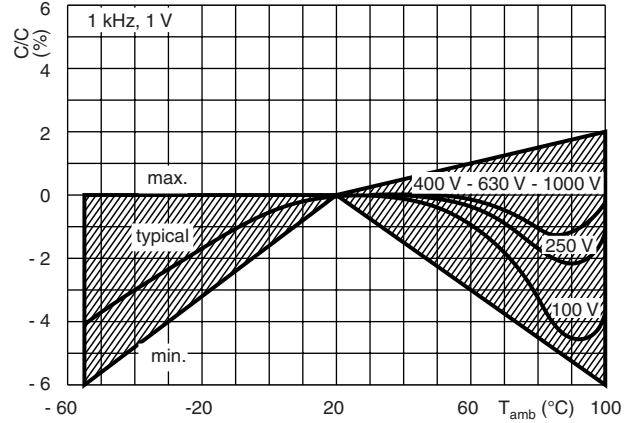

467, 469 - Impedance as a function of frequency (typical curve)

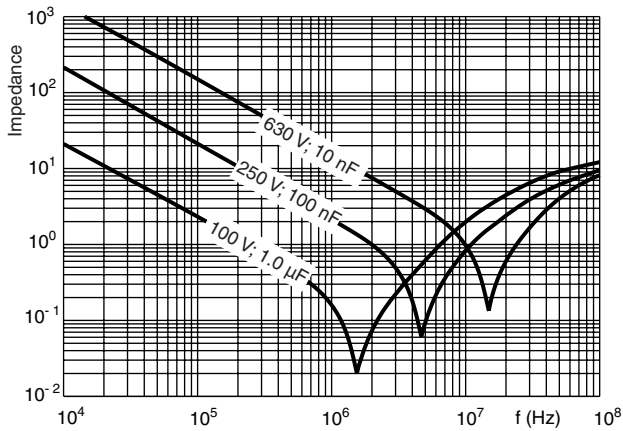

468 - Impedance as a function of frequency (typical curve)

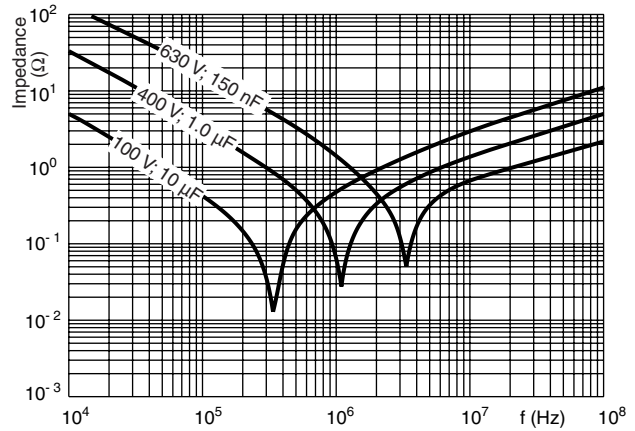

Max. DC and AC voltage as a function of temperature

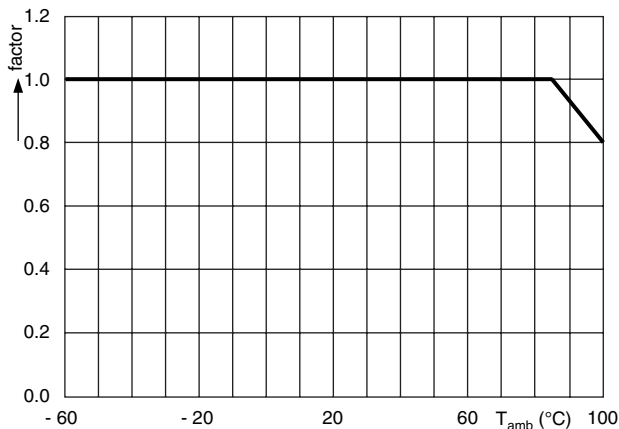



DC Film Capacitor
MKT Radial Lacquered Type

467, 469 - Max. RMS voltage as a function of frequency

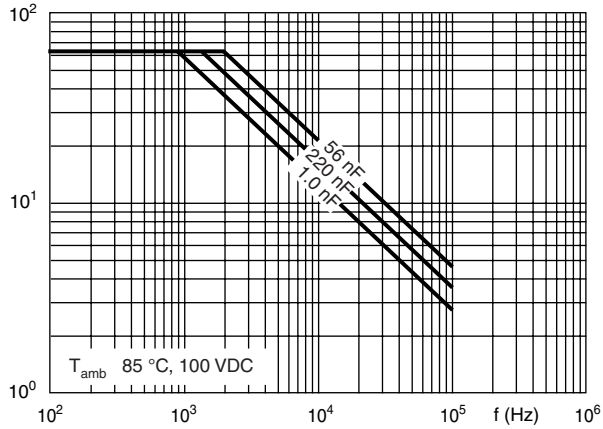

467, 469 - Max. RMS voltage as a function of frequency

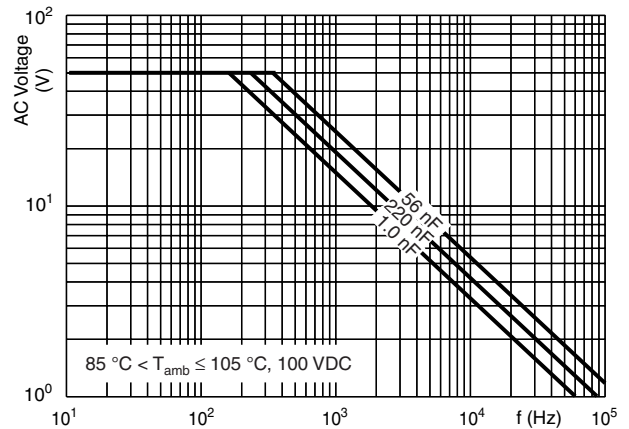

467, 469 - Max. RMS voltage as a function of frequency

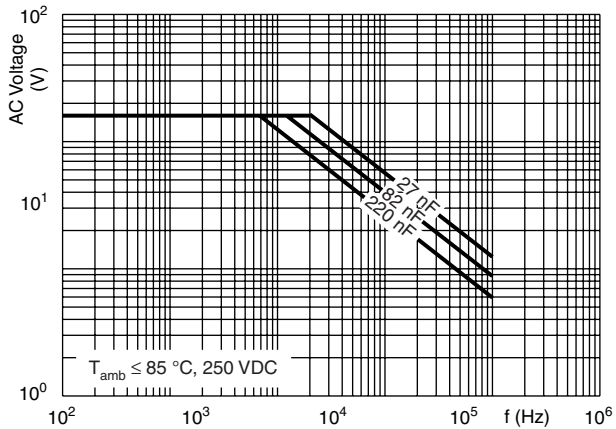

467, 469 - Max. RMS voltage as a function of frequency

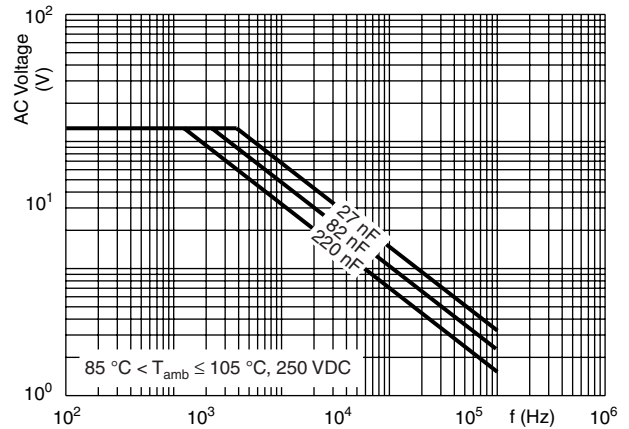

467, 469 - Max. RMS voltage as a function of frequency

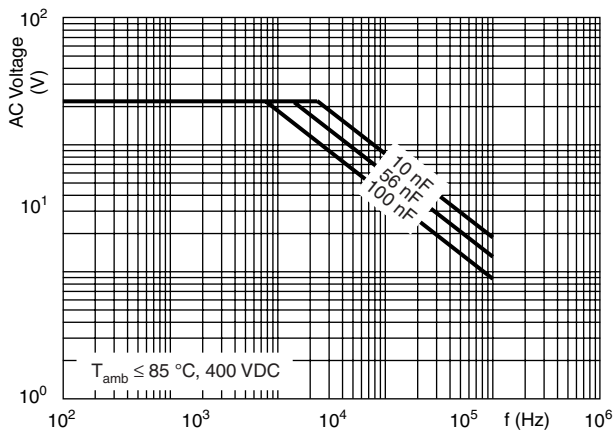

467, 469 - Max. RMS voltage as a function of frequency

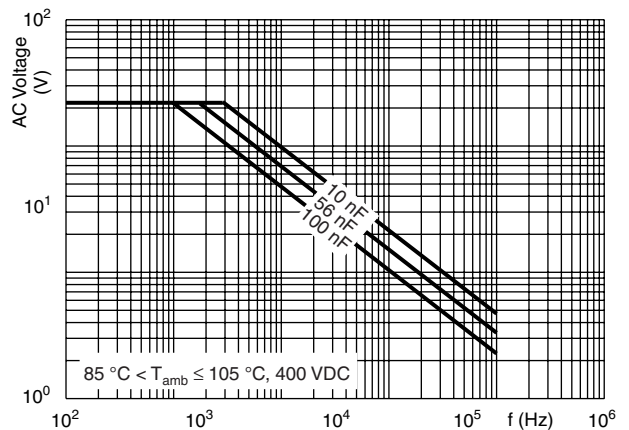

467, 469 - Max. RMS voltage as a function of frequency

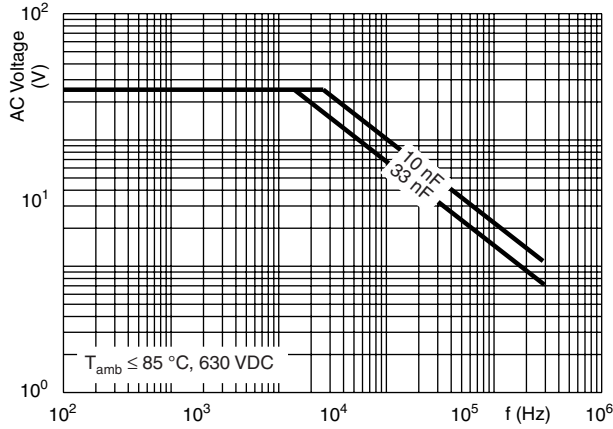

467, 469 - Max. RMS voltage as a function of frequency

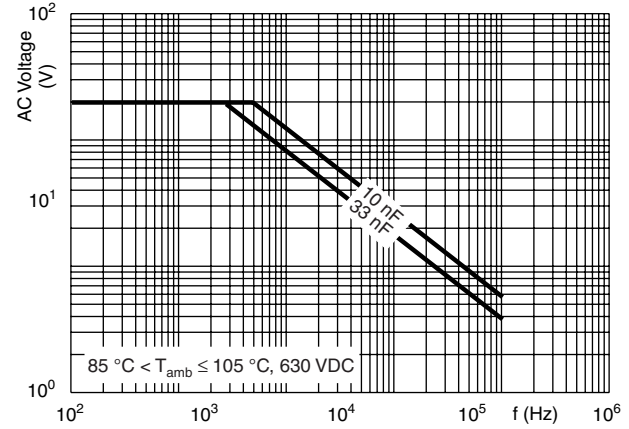

468 - Max. RMS voltage as a function of frequency

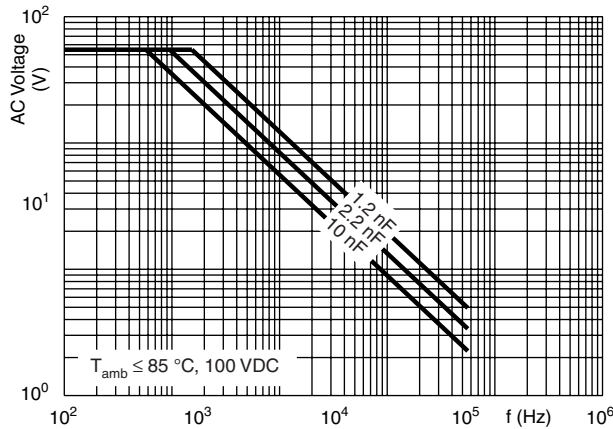

468 - Max. RMS voltage as a function of frequency

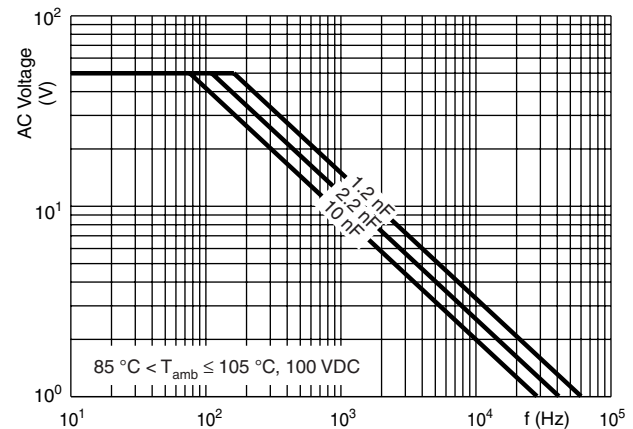

468 - Max. RMS voltage as a function of frequency

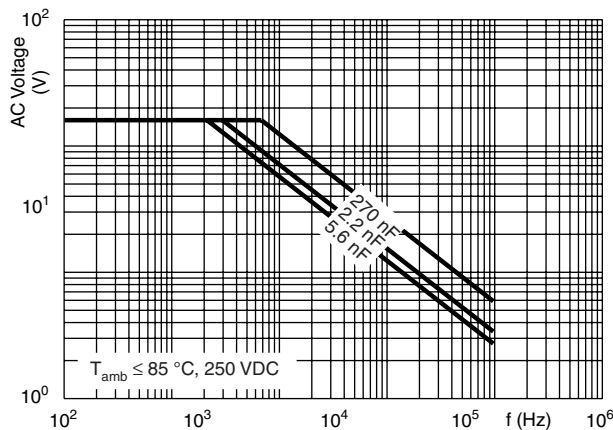

468 - Max. RMS voltage as a function of frequency

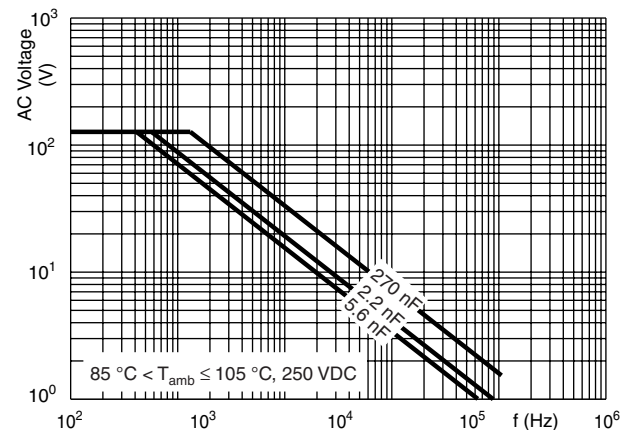



DC Film Capacitor
MKT Radial Lacquered Type

468 - Max. RMS voltage as a function of frequency

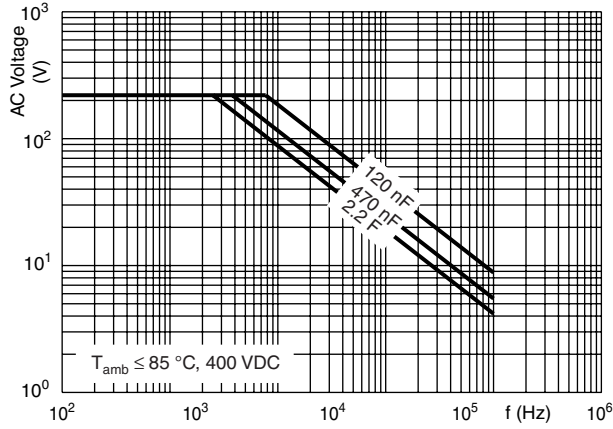

468 - Max. RMS voltage as a function of frequency

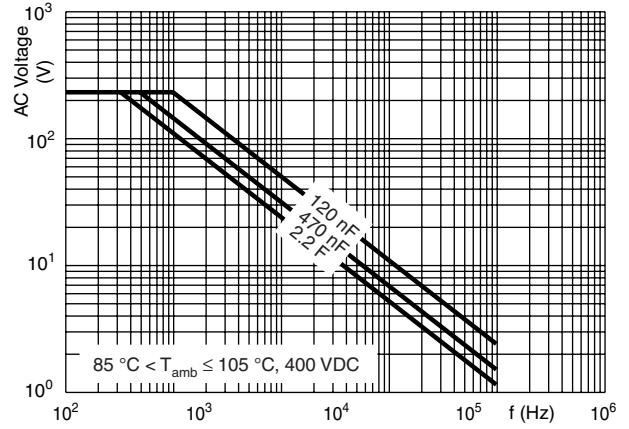

468 - Max. RMS voltage as a function of frequency

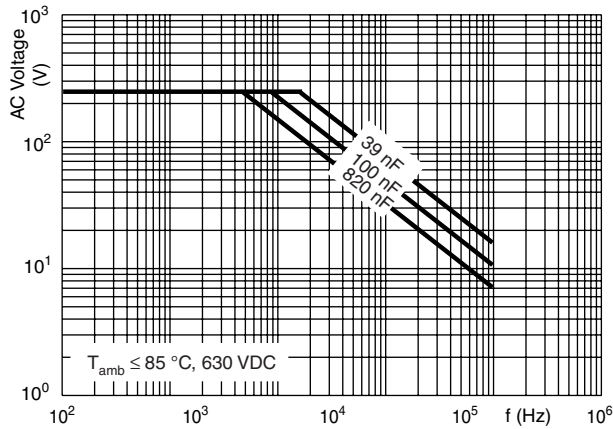

468 - Max. RMS voltage as a function of frequency

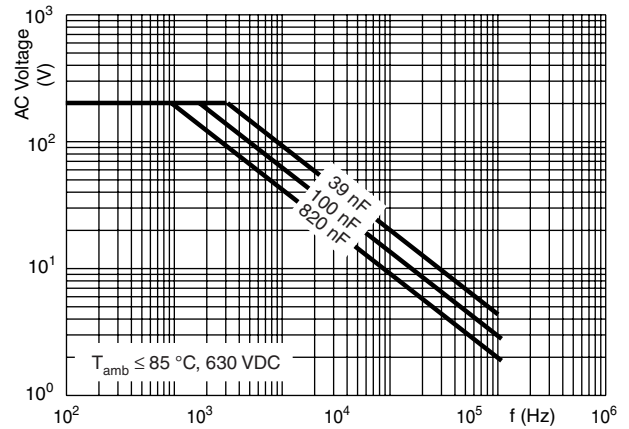

468 - Max. RMS voltage as a function of frequency

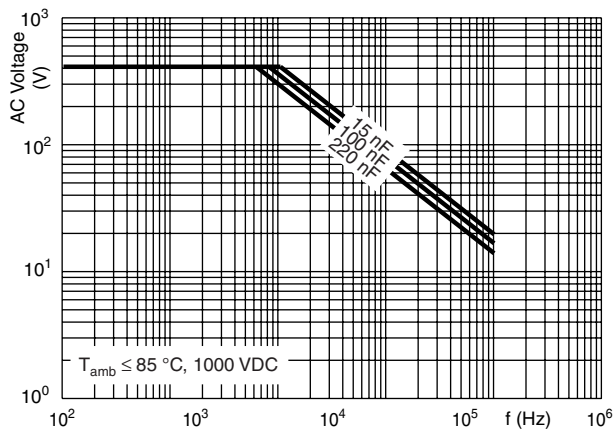

468 - Max. RMS voltage as a function of frequency

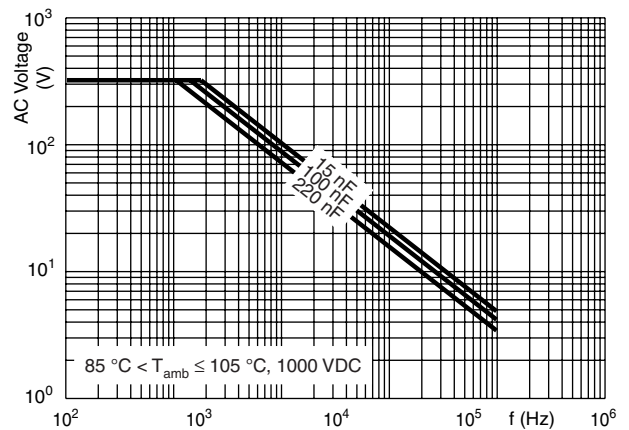



Tangent of loss angle as a function of frequency (typical curve)

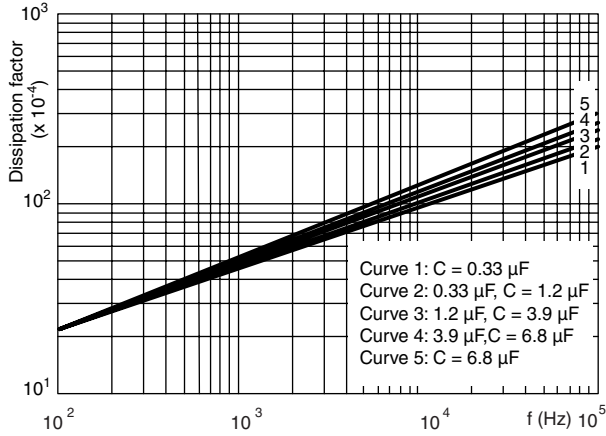

Insulation resistance as a function of the ambient temperature (typical curve)

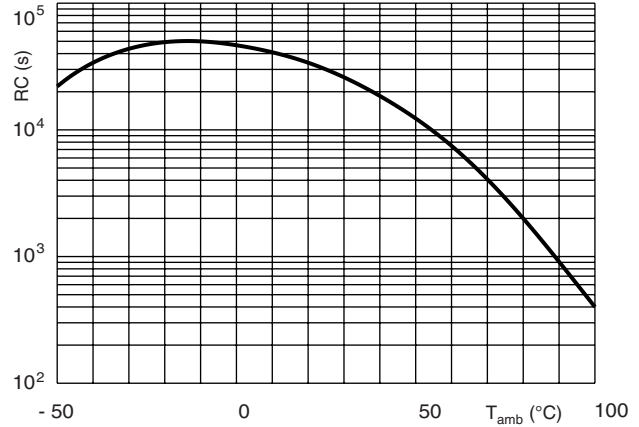

Maximum allowed component temperature rise (ΔT) as a function of the ambient temperature (T_{amb})

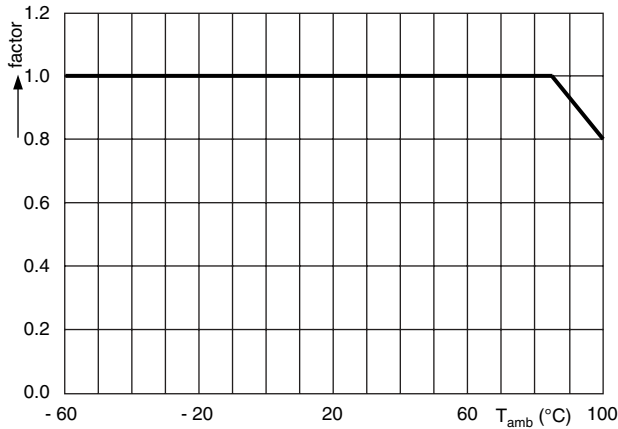

HEAT CONDUCTIVITY (G) AS A FUNCTION OF (ORIGINAL) PITCH AND CAPACITOR BODY THICKNESS IN mW/°C

| W_{max} (mm) | HEAT CONDUCTIVITY (mW/°C) | | | |
|-------------------|---------------------------|---------------|---------------|---------------|
| | PITCH 10 mm | PITCH 15.5 mm | PITCH 22.5 mm | PITCH 27.5 mm |
| 4.0 | 4.0 | 5.0 | - | - |
| 4.5 | 4.5 | 6.0 | - | - |
| 5.0 | 5.0 | 6.0 | 12.0 | 13.0 |
| 5.5 | 6.0 | 6.5 | 13.0 | 15.0 |
| 6.0 | 6.0 | 6.5 | 13.0 | 15.0 |
| 6.5 | 6.5 | 8.0 | 15.0 | 17.0 |
| 7.0 | - | 8.0 | 15.0 | 17.0 |
| 7.5 | - | 9.0 | 17.0 | 18.0 |
| 8.0 | - | 9.0 | 17.0 | 20.0 |
| 8.5 | - | 11.0 | 18.0 | 20.0 |
| 9.0 | - | 11.0 | 18.0 | 22.0 |
| 9.5 | - | 12.0 | 20.0 | 22.0 |
| 10.0 | - | 12.0 | 20.0 | 23.0 |
| 10.5 | - | - | 22.0 | 25.0 |
| 11.0 | - | - | - | 25.0 |
| 11.5 | - | - | - | 27.0 |

| W _{max.} (mm) | HEAT CONDUCTIVITY (mW/°C) | | | |
|---------------------------|---------------------------|---------------|---------------|---------------|
| | PITCH 10 mm | PITCH 15.5 mm | PITCH 22.5 mm | PITCH 27.5 mm |
| 12.0 | - | - | - | 27.0 |
| 12.5 | - | - | - | 30.0 |
| 13.0 | - | - | - | 30.0 |
| 13.5 | - | - | - | 30.0 |
| 14.0 | - | - | - | 30.0 |
| 14.5 | - | - | - | 33.0 |
| 15.0 | - | - | - | 33.0 |
| 15.5 | - | - | - | 37.0 |
| 16.0 | - | - | - | 37.0 |

POWER DISSIPATION AND MAXIMUM COMPONENT TEMPERATURE RISE

The power dissipation must be limited in order not to exceed the maximum allowed component temperature rise as a function of the free ambient temperature.

The power dissipation can be calculated according type detail specification "HQN-384-01/101: Technical Information Film Capacitors".

The component temperature rise (ΔT) can be measured (see section "Measuring the component temperature" for more details) or calculated by $\Delta T = P/G$:

- ΔT = Component temperature rise (°C)
- P = Power dissipation of the component (mW)
- G = Heat conductivity of the component (mW/°C)

MEASURING THE COMPONENT TEMPERATURE

A thermocouple must be attached to the capacitor body as in:

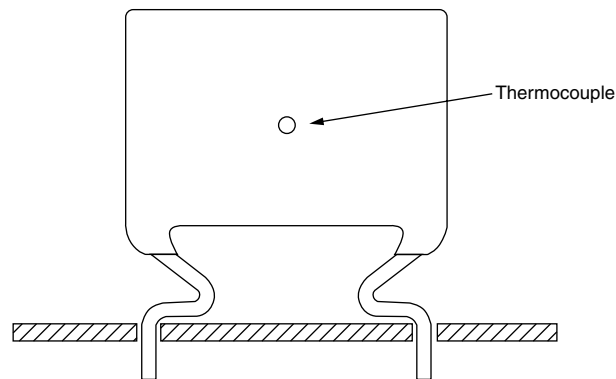

The temperature is measured in unloaded (T_{amb}) and maximum loaded condition (T_C).

The temperature rise is given by $\Delta T = T_C - T_{amb}$.

To avoid radiation or convection, the capacitor should be tested in a wind-free box.

APPLICATION NOTE AND LIMITING CONDITIONS

These capacitors are not suitable for mains applications as across-the-line capacitors without additional protection, as described hereunder. These mains applications are strictly regulated in safety standards and therefore electromagnetic interference suppression capacitors conforming the standards must be used.

To select the capacitor for a certain application, the following conditions must be checked:

1. The peak voltage (U_P) shall not be greater than the rated DC voltage (U_{Rdc})
2. The peak-to-peak voltage (U_{P-P}) shall not be greater than $2\sqrt{2} \times U_{Rac}$ to avoid the ionisation inception level



- The voltage pulse slope (dU/dt) shall not exceed the rated voltage pulse slope in an RC-circuit at rated voltage and without ringing. If the pulse voltage is lower than the rated DC voltage, the rated voltage pulse slope may be multiplied by U_{Rdc} and divided by the applied voltage.

For all other pulses following equation must be fulfilled:

$$2 \times \int_0^T \left(\frac{dU}{dt}\right)^2 \times dt < U_{Rdc} \times \left(\frac{dU}{dt}\right)_{rated}$$

T is the pulse duration.

The rated voltage pulse slope is valid for ambient temperatures up to 85 °C. For higher temperatures a derating factor of 3 % per K shall be applied.

- The maximum component surface temperature rise must be lower than the limits (see graph max. allowed component temperature rise).
- Since in circuits used at voltages over 280 V peak-to-peak the risk for an intrinsically active flammability after a capacitor breakdown (short circuit) increases, it is recommended that the power to the component is limited to 100 times the values mentioned in the table: "Heat conductivity"
- When using these capacitors as across-the-line capacitor in the input filter for mains applications or as series connected with an impedance to the mains the applicant must guarantee that the following conditions are fulfilled in any case (spikes and surge voltages from the mains included).

Voltage Conditions for 6 Above

| ALLOWED VOLTAGES | $T_{amb} \leq 85 \text{ }^\circ\text{C}$ | $85 \text{ }^\circ\text{C} < T_{amb} \leq 105 \text{ }^\circ\text{C}$ |
|--|--|---|
| Maximum continuous RMS voltage | U_{Rac} | $0.8 \times U_{Rac}$ |
| Maximum temperature RMS-overvoltage (< 24 h) | $1.25 \times U_{Rac}$ | U_{Rac} |
| Maximum peak voltage (V_{O-P}) (< 2 s) | $1.6 \times U_{Rdc}$ | $1.3 \times U_{Rdc}$ |

EXAMPLE

C = 330 nF - 100 V used for the voltage signal shown in next drawing.

$U_{P-P} = 80 \text{ V}$; $U_P = 70 \text{ V}$; $T_1 = 0.5 \text{ ms}$; $T_2 = 1 \text{ ms}$

The ambient temperature is 35 °C

Checking conditions:

- The peak voltage $U_P = 70 \text{ V}$ is lower than 100 Vdc
- The peak-to-peak voltage 80 V is lower than $2\sqrt{2} \times 63 \text{ Vac} = 178 U_{P-P}$
- The voltage pulse slope (dU/dt) = 80 V/500 μs = 0.16 V/ μs
This is lower than 20 V/ μs (see specific reference data for each version)
- The dissipated power is 60 mW as calculated with fourier terms
The temperature rise for $W_{max.} = 8.5 \text{ mm}$ and pitch = 15 mm will be 60mW/11 mW/°C = 5.5 °C
This is lower than 15 °C temperature rise at 35 °C, according figure max. allowed component temperature rise
- Not applicable
- Not applicable

Voltage Signal

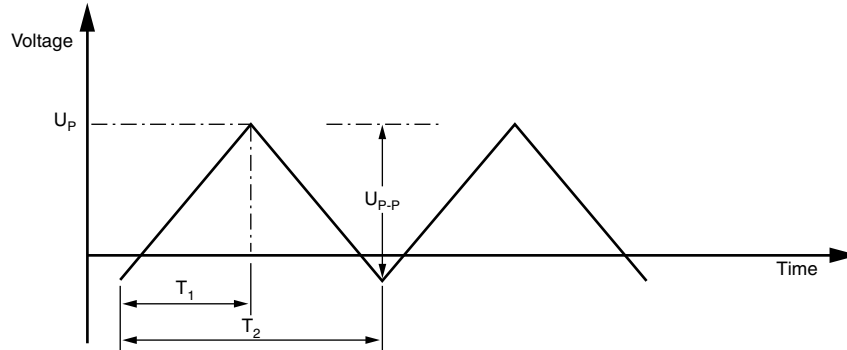

INSPECTION REQUIREMENTS

General Notes:

Sub-clause numbers of tests and performance requirements refer to the “Sectional Specification, Publication IEC 60384-2 and specific reference data”.

Group C Inspection Requirements

| SUB-CLAUSE NUMBER AND TEST | CONDITIONS | PERFORMANCE REQUIREMENTS |
|---|---|---|
| SUB-GROUP C1A PART OF SAMPLE OF SUB-GROUP C1 | | |
| 4.1 Dimensions (detail) | | As specified in chapters “General Data” of this specification |
| 4.3.1 Initial measurements | Capacitance Tangent of loss angle: For $C \leq 470$ nF at 100 kHz or for $C > 470$ nF at 10 kHz | |
| 4.3 Robustness of terminations | Tensile: Load 10 N; 10 s Bending: Load 5 N; 4 x 90° | No visible damage |
| 4.4 Resistance to soldering heat | Method: 1A Solder bath: 280 °C ± 5 °C Duration: 10 s | |
| 4.14 Component solvent resistance | Isopropylalcohol at room temperature Method: 2 Immersion time: 5 ± 0.5 min Recovery time: Min. 1 h, max. 2 h | |
| 4.4.2 Final measurements | Visual examination Capacitance Tangent of loss angle | No visible damage Legible marking $ \Delta C/C \leq 2\%$ of the value measured initially Increase of $\tan \delta$ ≤ 0.005 for: $C \leq 100$ nF or ≤ 0.010 for: 100 nF < $C \leq 220$ nF or ≤ 0.015 for: 220 nF < $C \leq 470$ nF and ≤ 0.003 for: $C > 470$ nF Compared to values measured in 4.3.1 |



| SUB-CLAUSE NUMBER AND TEST | CONDITIONS | PERFORMANCE REQUIREMENTS |
|--|---|---|
| SUB-GROUP C1B PART OF SAMPLE OF SUB-GROUP C1 | | |
| 4.6.1 Initial measurements | Capacitance Tangent of loss angle: For $C \leq 470$ nF at 100 kHz or for $C > 470$ nF at 10 kHz | No visible damage |
| 4.6 Rapid change of temperature | $\theta A = - 55$ °C $\theta B = + 100$ °C 5 cycles Duration $t = 30$ min | |
| 4.7 Vibration | Visual examination Mounting: See section "Mounting" of this specification Procedure B4 Frequency range: 10 Hz to 55 Hz Amplitude: 0.75 mm or Acceleration 98 m/s ² (whichever is less severe) Total duration 6 h | No visible damage |
| 4.7.2 Final inspection | Visual examination | No visible damage |
| 4.9 Shock | Mounting: See section "Mounting" of this specification Pulse shape: Half sine Acceleration: 490 m/s ² Duration of pulse: 11 ms | |
| 4.9.3 Final measurements | Visual examination Capacitance Tangent of loss angle Insulation resistance | No visible damage $ \Delta C/C \leq 3$ % of the value measured in 4.6.1 Increase of $\tan \delta$ ≤ 0.005 for: $C \leq 100$ nF or ≤ 0.010 for: 100 nF $< C \leq 220$ nF or ≤ 0.015 for: 220 nF $< C \leq 470$ nF and ≤ 0.003 for: $C > 470$ nF Compared to values measured in 4.6.1 As specified in section "Insulation Resistance" of this specification |
| SUB-GROUP C1 COMBINED SAMPLE OF SPECIMENS OF SUB-GROUPS C1A AND C1B | | |
| 4.10 Climatic sequence | | |
| 4.10.2 Dry heat | Temperature: + 105 °C Duration: 16 h | |
| 4.10.3 Damp heat cyclic Test Db, first cycle | | |
| 4.10.4 Cold | Temperature: - 55 °C Duration: 2 h | |
| 4.10.6 Damp heat cyclic Test Db, remaining cycles | | |
| 4.10.6.2 Final measurements | Voltage proof = U_{Rdc} for 1 min within 15 min after removal from testchamber Visual examination Capacitance Tangent of loss angle Insulation resistance | No breakdown of flash-over No visible damage Legible marking $ \Delta C/C \leq 5$ % of the value measured in 4.4.2 or 4.9.3 Increase of $\tan \delta$ ≤ 0.007 for: $C \leq 100$ nF or ≤ 0.010 for: 100 nF $< C \leq 220$ nF or ≤ 0.015 for: 220 nF $< C \leq 470$ nF and ≤ 0.005 for: $C > 470$ nF Compared to values measured in 4.3.1 or 4.6.1 ≥ 50 % of values specified in section "Insulation Resistance" of this specification |



DC Film Capacitor
MKT Radial Lacquered Type

| SUB-CLAUSE NUMBER AND TEST | CONDITIONS | PERFORMANCE REQUIREMENTS |
|---|--|--|
| SUB-GROUP C2 | | |
| 4.11 Damp heat steady state 4.11.1 Initial measurements 4.11.3 Final measurements | 56 days, 40 °C, 90 % to 95 % RH Capacitance Tangent of loss angle at 1 kHz Voltage proof = U_{Rdc} for 1 min within 15 min after removal from testchamber Visual examination Capacitance Tangent of loss angle Insulation resistance | No breakdown of flash-over No visible damage Legible marking $ \Delta C/C \leq 5\%$ of the value measured in 4.11.1. Increase of $\tan \delta \leq 0.005$ Compared to values measured in 4.11.1 $\geq 50\%$ of values specified in section "Insulation Resistance" of this specification |
| SUB-GROUP C3 | | |
| 4.12 Endurance | Duration: 2000 h $1.25 \times U_{Rdc}$ at 85 °C $1.0 \times U_{Rdc}$ at 105 °C | |
| 4.12.1 Initial measurements 4.12.5 Final measurements | Capacitance Tangent of loss angle: For $C \leq 470$ nF at 100 kHz or for $C > 470$ nF at 10 kHz Visual examination Capacitance Tangent of loss angle Insulation resistance | No visible damage Legible marking $ \Delta C/C \leq 5\%$ compared to values measured in 4.12.1 Increase of $\tan \delta$ ≤ 0.005 for: $C \leq 100$ nF or ≤ 0.010 for: 100 nF < $C \leq 220$ nF or ≤ 0.015 for: 220 nF < $C \leq 470$ nF and ≤ 0.003 for: $C > 470$ nF Compared to values measured in 4.12.1 $\geq 50\%$ of values specified in section "Insulation Resistance" of this specification |
| SUB-GROUP C4 | | |
| 4.13 Charge and discharge 4.13.1 Initial measurements 4.13.3 Final measurements | 10 000 cycles Charged to U_{Rdc} Discharge resistance: $R = \frac{U_R}{C \times 2.5 \times (dU/dt)_R}$ Capacitance Tangent of loss angle: For $C \leq 470$ nF at 100 kHz or for $C > 470$ nF at 10 kHz Capacitance Tangent of loss angle Insulation resistance | $ \Delta C/C \leq 3\%$ compared to values measured in 4.13.1 Increase of $\tan \delta$ ≤ 0.005 for: $C \leq 100$ nF or ≤ 0.010 for: 100 nF < $C \leq 220$ nF or ≤ 0.015 for: 220 nF < $C \leq 470$ nF and ≤ 0.003 for: $C > 470$ nF Compared to values measured in 4.13.1 $\geq 50\%$ of values specified in section "Insulation Resistance" of this specification |



Disclaimer

All product specifications and data are subject to change without notice.

Vishay Intertechnology, Inc., its affiliates, agents, and employees, and all persons acting on its or their behalf (collectively, "Vishay"), disclaim any and all liability for any errors, inaccuracies or incompleteness contained herein or in any other disclosure relating to any product.

Vishay disclaims any and all liability arising out of the use or application of any product described herein or of any information provided herein to the maximum extent permitted by law. The product specifications do not expand or otherwise modify Vishay's terms and conditions of purchase, including but not limited to the warranty expressed therein, which apply to these products.

No license, express or implied, by estoppel or otherwise, to any intellectual property rights is granted by this document or by any conduct of Vishay.

The products shown herein are not designed for use in medical, life-saving, or life-sustaining applications unless otherwise expressly indicated. Customers using or selling Vishay products not expressly indicated for use in such applications do so entirely at their own risk and agree to fully indemnify Vishay for any damages arising or resulting from such use or sale. Please contact authorized Vishay personnel to obtain written terms and conditions regarding products designed for such applications.

Product names and markings noted herein may be trademarks of their respective owners.